

NEO[®] S-Series Tape Libraries

Administrator's Guide







NEOs StorageLoader (1U)



NEOs T24 (2U)

©2022 Overland-Tandberg. All rights reserved.

NEO®, NEO Series®, Overland®, Overland Storage®, Overland-Tandberg™, Overland Technologies™, PowerLoader®, VR2®, and  are trademarks of Overland Storage, Inc., dba Overland-Tandberg.

AccuGuard®, AccuVault®, BizNAS™, QuadPak®, QuikStation®, QuikStor®, RDX®, , , RDXPRESS™, RDXPRO™, , RDX+™, StorageLoader®, **StorageLoader™**, SupportSuite®, Tandberg™, **TANDBERG DATA** , **TANDBERG DATA STORAGELOADER™**, Tandberg SecureService®, and Tandberg StorageLibrary® are trademarks of Tandberg Data Holdings S.a.r.l., a subsidiary of Overland Storage, Inc., dba Overland-Tandberg.

All other brand names or trademarks are the property of their respective owners.

The names of companies and individuals used in examples are fictitious and intended to illustrate the use of the software. Any resemblance to actual companies or individuals, whether past or present, is coincidental.

PROPRIETARY NOTICE

The information contained in this document is subject to change without notice.

All information contained in or disclosed by this document is considered proprietary by Overland-Tandberg. By accepting this material the recipient agrees that this material and the information contained therein are held in confidence and in trust and will not be used, reproduced in whole or in part, nor its contents revealed to others, except to meet the purpose for which it was delivered. It is understood that no right is conveyed to reproduce or have reproduced any item herein disclosed without express permission from Overland-Tandberg.

Overland-Tandberg provides this manual as is, without warranty of any kind, either expressed or implied, including, but not limited to, the implied warranties of merchantability and fitness for a particular purpose. Overland-Tandberg may make improvements or changes in the product(s) or programs described in this manual at any time. These changes will be incorporated in new editions of this publication.

Overland-Tandberg assumes no responsibility for the accuracy, completeness, sufficiency, or usefulness of this manual, nor for any problem that might arise from the use of the information in this manual.

FW 6.00

Overland-Tandberg
4542 Ruffner Street, Suite 250
San Diego, CA 92111 USA

TEL 1.800.729.8725 (toll free)
1.858.571.5555
FAX 1.858.571.3664

Tandberg Data GmbH
Nikolaus-Groß-Straße 13
44329 Dortmund, Germany

TEL +49 231 5436 0
FAX +49 231 5436 111



www.overlandtandberg.com



Preface

Topics in Preface

- [Audience and Purpose](#)
- [General Warnings](#)
- [Product Warranty Cautions](#)
- [Conventions](#)
- [Regulatory Information](#)
- [Product Documentation](#)
- [Firmware Updates](#)
- [Technical Support](#)

Audience and Purpose

This guide is intended for system and network administrators charged with installing and maintaining a NEO S-Series Tape Library. It provides information on the installation, configuration, operation, service, and maintenance of the library. Administrators should be familiar with the basic concepts and tasks of network administration.

Warnings

- Only trained personnel should operate this equipment.
- Read all documentation and procedures before installation or operation.
- The tape library must only be installed in a Restricted Area.
- Only personnel with technical and product-safety training should be provided access to the library.
- For safety reasons, the default administrator PIN for the Operator Control Panel needs to be changed during initial configuration.
- Hazardous moving parts exist inside this product. Do not insert tools or any parts of your body into the interior of the library while the mailslot or magazine is pulled out.
- Do not insert any tools or any parts of your body into drive bay openings or any other openings of an operating system.

Avertissement

- Cet équipement ne doit être utilisé que par un personnel formé.
- Lisez la totalité de la documentation et des procédures avant toute installation ou utilisation.
- Ce produit est conçu pour être installé et utilisé dans un local approprié.
- Seul un personnel avec la formation technique et de sécurité des produits devrait avoir accès à la bibliothèque.

- Pour des raisons de sécurité, le code PIN administrateur par défaut doit être changé au moment de la configuration initiale.
- Des pièces mobiles dangereuses se trouvent à l'intérieur de ce produit. Ne pas insérer d'outils ou de parties de votre corps à l'intérieur de la bibliothèque pendant que le slot import/ export ou un tiroir est sorti.
- N'insérez pas d'outils ni partie du corps dans les ouvertures de la robotique lorsque le système est en marche.

Note

- Ventilation – Place the product in a location that does not interfere with proper ventilation.
- Heat – Place the product in a location away from heat sources.
- Power sources – Connect the product to a power source only of the type directed in the operating instructions or as marked on the product.
- Power cord protection – Place the AC line cord so that it is not possible to be walked on or pinched by items placed upon or against it.
- Object and liquid entry – Insure that objects do not fall onto and that liquids are not spilled into the product's enclosure.

Remarque

- Ventilation – Placez le produit dans un endroit qui n'interfère pas avec une ventilation appropriée.
- Chaleur – Placez le produit dans un endroit loin de sources de chaleur.
- Alimentation électrique – Veuillez ne brancher le produit qu'à une source d'alimentation correspondant aux instructions figurant dans le mode d'emploi ou comme directement indiqué sur le produit.
- Protection du cordon d'alimentation – Placez le cordon d'alimentation principal de sorte qu'il ne soit pas possible de marcher dessus ou d'être écrasé par des objets placés sur ou contre.
- Pénétration d'objets et de liquide – Assurez-vous que des objets ne tombent pas sur le châssis et que des liquides ne soient pas déversés dans le châssis.

General Warnings



DANGER

High voltage – Risk of electric shock

- Do not remove power supply covers. No user-serviceable parts are inside unless specifically identified.
- Refer servicing to qualified service personnel.

Tension élevée – Risque de choc électrique

- Ne pas retirer le couvercle de l'alimentation. Aucune pièce réparable par l'utilisateur ne se trouve à l'intérieur à moins que celle-ci ne soit spécifiquement identifiée.
- Confier toute réparation à un personnel qualifié.



MECHANICAL HAZARD

Danger – Risk of hand pinching, can trap hands, fingers and cause serious injury. Keep hands clear during operation.



DANGER MÉCANIQUE

Danger – Risque de se coincer la main et de se coincer les mains ainsi que les doigts le tout pouvant entrainer de graves blessures. Gardez les mains à l'écart pendant le fonctionnement.

Achtung:
Vor Öffnen des Gerätes
alle Netzstecker ziehen!

Attention:
Remove all power cords
before opening the unit!

Attention:
Débranchez toutes les fiches d'alimentation avant d'ouvrir l'équipement!

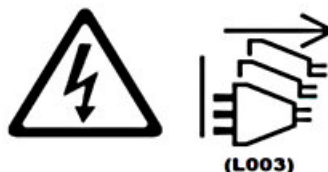

Electrostatic Discharge

To prevent damaging the system, be aware of the precautions you need to follow when setting up the system or handling parts. A discharge of static electricity from a finger or other conductor may damage system boards or other static-sensitive devices. This type of damage may reduce the life expectancy of the device.

Preventing Electrostatic Damage. To prevent electrostatic damage, observe the following precautions:

- Avoid hand contact by transporting and storing products in static-safe containers.
- Keep electrostatic-sensitive parts in their containers until they arrive at static-free workstations.
- Place parts on a grounded surface before removing them from their containers.
- Avoid touching pins, leads, or circuitry.
- Always be properly grounded when touching a static-sensitive component or assembly. See the next section.

Grounding Methods. There are several methods for grounding. Use one or more of the following methods when handling or installing electrostatic-sensitive parts:

- Use a wrist strap connected by a ground cord to a grounded workstation or computer chassis. Wrist straps are flexible straps with a minimum of 1 megohm (± 10 percent) resistance in the ground cords. To provide proper ground, wear the strap snug against the skin.
- Use heel straps, toe straps, or boot straps at standing workstations. Wear the straps on both feet when standing on conductive floors or dissipating floor mats.
- Use conductive field service tools.
- Use a portable field service kit with a folding static-dissipating work mat.

If you do not have any of the suggested equipment for proper grounding, have an authorized reseller install the part. For more information on static electricity, or assistance with product installation, contact your authorized reseller.

Product Warranty Cautions

The customer should only perform the service and repair actions on the tape library components as described in this document. Any other actions needed should only be performed by an authorized service center.

The warranty for the tape library shall not apply to failures of any unit when:



- The tape library is repaired or modified by anyone other than the manufacturer's personnel or approved agent.
- The tape library is physically abused or used in a manner that is inconsistent with the operating instructions or product specification defined by the manufacturer.
- The tape library fails because of accident, misuse, abuse, neglect, mishandling, misapplication, alteration, faulty installation, modification, or service by anyone other than the factory service center or its approved agent.
- The tape library is repaired by anyone, including an approved agent, in a manner that is contrary to the maintenance or installation instructions supplied by the manufacturer.
- The manufacturer's serial number tag is removed.
- The tape library is damaged because of improper packaging on return.

Warranty becomes immediately void in the event of unauthorized repairs or modifications.

Conventions

This document exercises several alerts and typographical conventions.

Alerts

Convention	Description & Usage
NOTE: Text	A Note indicates neutral or positive information that emphasizes or supplements important points of the main text. A note supplies information that may apply only in special cases, for example, memory limitations or details that apply to specific program versions.
 IMPORTANT	An Important note is a type of note that provides information essential to the completion of a task or that can impact the product and its function.
 CAUTION	A Caution contains information that the user needs to know to avoid damaging or permanently deleting data or causing physical damage to the hardware or system.
 WARNING WARNUNG	A Warning contains information concerning personal safety. Failure to follow directions in the warning could result in bodily harm or death. Eine <i>Warnung</i> enthält Informationen zur persönlichen Sicherheit. Das Nichtbeachten der Anweisungen in der Warnung kann zu Verletzungen oder zum Tod führen.
AVERTISSEMENT	Un Canadien avertissement comme celui-ci contient des informations relatives à la sécurité personnelle. Ignorer les instructions dans l'avertissement peut entraîner des lésions corporelles ou la mort.

Typographical Conventions

Convention	Description & Usage
Button_name	Words in this special boldface font indicate command buttons found in the Remote Management Interface (RMI) or Operator Control Panel (OCP).
Ctrl-Alt-R	Denotes the keys that you press simultaneously. In this example, hold down the Ctrl and Alt keys and press the R key.
Menu Flow Indicator (>)	Words with a greater than sign between them indicate the flow of actions to accomplish a task. For example, Setup > Passwords > User indicates that you should press the Setup button, then the Password button, and finally the User button to accomplish a task.
<i>Courier Italic</i>	Used to exemplify a variable for which you must substitute a value.
Courier Bold	Represents commands or text in a command-line interface (CLI).

Information contained in this guide has been reviewed for accuracy, but not for product warranty because of the various environments, operating systems, or settings involved. Information and specifications may change without notice.

Regulatory Information

Disposal of Waste Equipment by Users in Private Households in the European Union and Norway



This symbol on the product or on its packaging indicates that this product must not be disposed of with your other household waste. Instead, it is your responsibility to dispose of your equipment by handling it over to a designated collection point for the recycling of waste electrical and electronic equipment. The separate collection and recycling of your waste equipment at this time of disposal will help to conserve natural resources and ensure that it is recycled in a manner that protects human health and the environment. For more information about where you can drop off your waste equipment for recycling, please contact your local city office, your household waste disposal service, or the shop where you purchased the product.

CE Mark

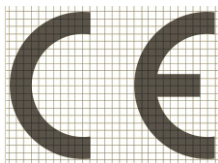

The CE mark is a mandatory conformity mark on many products placed on the single market in the European Economic Area (EEA). The CE marking certifies that a product has met EU consumer safety, health or environmental requirements.

NRTL Mark



FCC (United States)



The computer equipment described in this manual generates and uses radio frequency (RF) energy. If the equipment is not installed and operated in strict accordance with the manufacturer's instructions, interference to radio and television reception might result.

This equipment complies with Part 15 of the FCC Rules. Operation is subject to the following conditions: (1) This device may not cause harmful interference, and (2) this device must accept any interference received, including interference that may cause undesired operation.

Part 15, Class A, of the FCC Rules, is designed to provide reasonable protection against radio and television interference in a residential installation. Although the equipment has been tested and found to comply with the allowed RF emission limits, as specified in the above-cited Rules, there is no guarantee that interference will not occur in a particular installation. Interference can be determined by turning the equipment off and on while monitoring radio or television reception. The user may be able to eliminate any interference by implementing one or more of the following measures:

- Reorient the affected device and/or its receiving antenna.
- Increase the distance between the affected device and the computer equipment.
- Plug the computer and its peripherals into a different branch circuit from that used by the affected device.
- If necessary, consult an experienced radio/television technician for additional suggestions.

Canadian Verification

This Class A digital apparatus meets all requirements of the Canadian Interference-Causing Equipment Regulations (ICES-003, Class A).

Product Documentation

NEO product documentation and additional literature are available online at the Overland-Tandberg Knowledge Base:

<https://www.overlandtandberg.com/knowledgebase/>

Go to Tape Archive Solutions (NEO & LTO Drives). There are four types of documents you can view and download:

- [NEO & LTO Firmware Links & Release Notes](#)
- [NEO & LTO Manuals and Guides](#)
- [NEO & LTO Technical Bulletins & FAQs](#)
- [NEO Integration & Solution Briefs](#)

Firmware Updates

The latest release of the NEO S-Series firmware can be obtained from the Downloads page at the Overland Storage website:

https://download.overlandtandberg.com/Firmware/Neo_Series/NeoS/

Follow the appropriate instructions to download the **latest** software file.

Technical Support

You can get additional technical support information on the Contact Us web page at:

<https://www.overlandtandberg.com/contact-us/>

For a complete list of support types, levels, and times, visit our website at:

<https://www.overlandtandberg.com/service-support/contact-service-support/>



Contents

Preface

Chapter 1: Product Overview

Front Panel	13
Rear Panel	14
Power Supplies	15
Tape Drive Components	16
Library Controller	17
Ethernet Port	17
User Interfaces	18
Default Settings	18

Chapter 2: Installation & Configuration

Installation Preparation	20
Location Requirements	20
LUN Scanning	21
Serial Attached SCSI (SAS) Connections	21
Fibre Channel Connections	21
Host Preparation	21
Installation Precautions	22
Unpack and Install the Library	22
Populating the Library with Cartridges	22

Chapter 3: Media and Magazines

LTO Ultrium Data Cartridge	25
Tape Cartridge Barcode Labels	25
Write Protecting Tape Cartridges	27
LTO Cartridge Capacities	27
LTO Read and Write Compatibility	28
LTO-9 Cartridge Initialization	28
Write Once, Read Many (WORM)	29
Cleaning Cartridge	29
Cartridge Care and Handling	30
Environmental and Shipping Specifications for Tape Cartridges	33
Disposing of Tape Cartridges	33
Tape Magazines	34
Slot Numbering	34
Mailslots	35
Manual Magazine Release	35

Chapter 4: Operator Control Panel

Overview	36
----------------	----

Operation Modes	36
OCP Rules	37
Power-Up Display	37
OCP LEDs	37
Input Modes	38
Power ON/OFF	38
Menu Flowcharts	39
NEOs StorageLoader (1U) Menu	39
NEOs T24 (2U) Tape Library Menus	46

Chapter 5: Remote Management Interface

Overview	53
RMI Icons	54
Login	54
Identity Screens	55
Library (Info)	55
Drive (Info)	56
Network (Info)	57
Status Screens	58
Library (Status)	58
Drive (Status)	59
Inventory (Status)	60
Configuration Screens	61
System	61
Logical Libraries	62
License Key	62
Drive	63
Network	63
SNMP	64
User	66
Date/Time	67
Log	68
Email Notification	68
Restore Defaults	69
Operations Screens	70
Move Media	70
Inventory	70
Magazines	70
Service Screens	71
General Diagnostic	71
Drive Diagnostic	72
Firmware	72
Reboot	73
Library Logs	73
Clean Drive	74
Cartridge Memory	75

Chapter 6: Partitioning the Library

Drive Naming	76
Mixing of Drives	76
Single-Partition Configuration	76

Two-Partition Configuration	77
SCSI Element Addressing	77
Element Address Reporting	77

Chapter 7: Troubleshooting

How the Library Reports Problems	80
Library Error Message Content	80
Diagnosing a Problem	81
Isolating Problems	84
Isolating Library Power Problems	84
Isolating Drive Problems	84
Isolating RMI Problems	85
Isolating Host Attachment Interface Problems	85
Installation and Configuration Problems	86
Interpreting Front Panel LEDs	87
Reseating Cables	88
Emailing Logs	88
Unlocking the Cartridge Magazine Manually	88
Verify the Library	89

Appendix A: Specifications

Hardware Specifications	90
Operational Specifications	90
Electrical Specifications	91
Product Environment	91
Supported Servers, Operating Systems, and Software	92
Supported Device Drivers	92

Appendix B: Error Codes

Library Error Codes	93
Drive Error Codes	94
Remote Management Interface Error Messages	94
Trap Definitions (Types)	95

Appendix C: TapeAlert Flags

Library Supported TapeAlert Flags	96
Tape Drive Supported TapeAlert Flags	98

Master Glossary & Acronym List

Index

1

Product Overview

The NEO S-Series tape libraries provide compact, high-capacity, low-cost solutions for simple, unattended data backup and archive. Available in 1U and 2U rack-mountable appliances with easy access to tape cartridges via removable magazines and mailslots, they incorporate the latest half-height LTO tape drives (LTO-9, LTO-8, LTO-7, LTO-6, and LTO-5).

They are equipped with either a mini-SAS (Serial Attached SCSI) connector with up to 6.0 Gbps data transfer rate, mini-SAS HD connector with up to 12.0 Gbps data transfer rate, or an LC optical FC (Fibre Channel) connector with up to 8.0 Gbps data transfer rate.

Topics in Product Overview:

- [Front Panel](#)
- [Rear Panel](#)
- [Power Supplies](#)
- [Tape Drive Components](#)
- [Library Controller](#)
- [Ethernet Port](#)
- [User Interfaces](#)
- [Default Settings](#)

Front Panel

These graphics and table illustrate the front panel components:

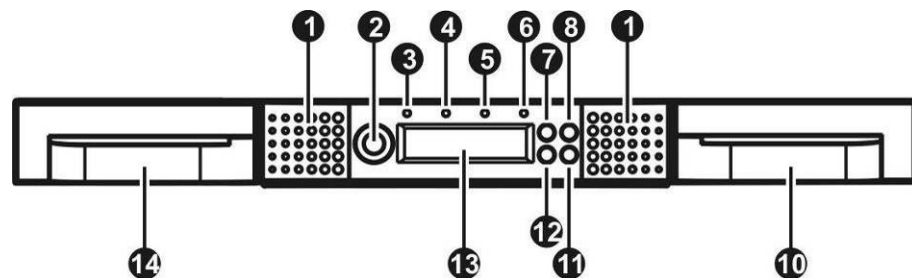

Figure 1-1: NEOs StorageLoader (1U) Front Panel

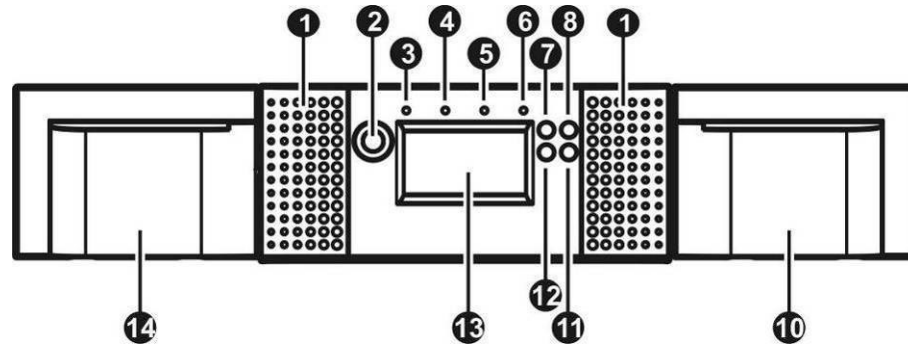

Figure 1-2: NEOs T24 Tape Library (2U) Front Panel

No.	Component	Description
1	Air Vents	Helps keep the library at a normal operating temperature.
2	Power Button	Pressing the button will initiate a controlled power down of the library (soft power down).
3	Ready/Activity LED, Green	Illuminated during power on. Blinking during tape or library robotics activity.
4	Clean LED, Amber	Illuminated when the tape drive has determined that a cleaning tape should be used. Cleaning is only necessary when the library directs you to do so. Additional cleaning is not necessary.
5	Attention LED, Amber	Illuminated when the library has detected a condition that requires attention by the operator.
6	Error LED, Amber	Illuminated when an unrecoverable tape drive or library error occurs. A corresponding error message is shown on the OCP.
7	Up Button	Used to navigate backward through menu items.
8	Cancel Button	Used to cancel a user action and return to the last menu item.
9	N/A	(Not used)
10	Right Magazines	Removable magazine where tape cartridges are stored.
11	Enter Button	Used to enter to a sub menu or execute an action.
12	Down Button	Used to navigate forward through menu items.
13	Operator Control Panel (OCP)	Consists of 128 x 64 characters. The OCP displays actions and status information, menu items, or error messages equivalent to the operation mode.
14	Left Magazine with Mailslot	Removable magazine where tape cartridges are stored. The first slot or slots are designated as a Mailslot.

Rear Panel

The rear panel of the NEO S-Series libraries provide access to the drive interface connectors, the power connector, Ethernet, serial and USB ports, and the magazine release holes. All libraries support SAS and Fibre Channel tape drives.

The position of the appended devices on the rear panel is in all libraries common. The power supply is on the left side, tape drives are in the middle and the library controller is on the right side of the library.

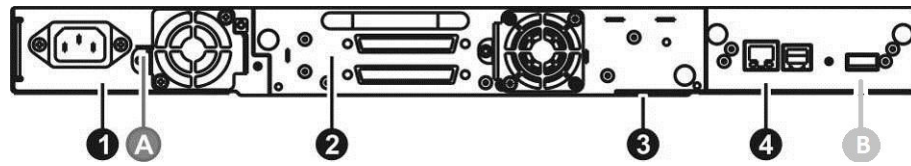

Figure 1-3: NEOs StorageLoader (1U) Rear Panel

No.	Description
1	Power Supply
2	Tape Drives
3	Pull-out Tab with Serial Number
4	Library Controller
A	Storage Location for Shipping Lock
B	USB Port for Firmware Upgrades

Power Supplies

The power supply unit (PSU) utilized is dependent on the library model.

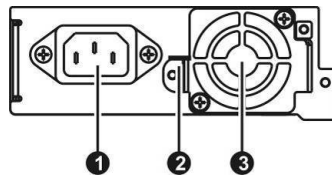

Figure 1-4: NEOs StorageLoader (1U) Power Supply

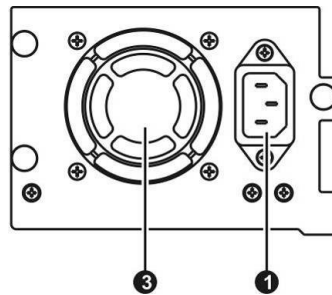

Figure 1-5: NEOs T24 Tape Library (2U) Power Supply

No.	Description
1	Power Connector (110/220 VAC)
2	Storage Location for Shipping Lock (1U StorageLoader only)
3	Power Supply Fan Vent

Tape Drive Components

Components of all LTO generations of drives based on type (SAS/FC):

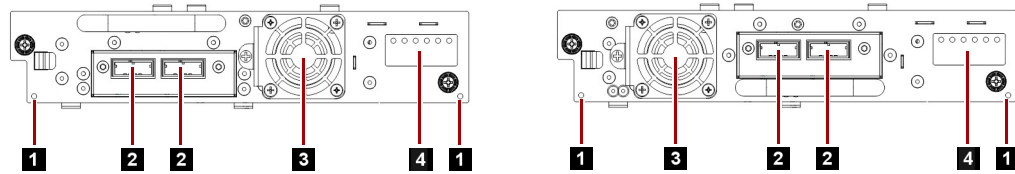

Figure 1-6: SAS Half-Height Tape Drives

No.	Description
1	Magazine Release Holes
2	SAS Connectors
3	Drive Fan Vent
4	Tape Drive LEDs

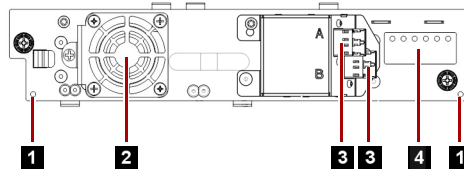

Figure 1-7: FC Half-Height Tape Drives

No.	Description
1	Magazine Release Holes
2	Drive Fan Vent
3	FC Connectors
5	Tape Drive LED

Library Controller

The library controller, with several ports and an LED, controls both the library and the drives that are installed. It also manages the library’s power supplies.

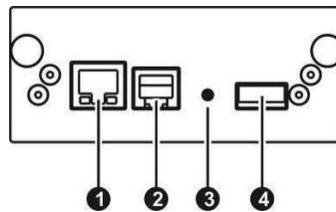

Figure 1-8: Library Controller

No.	Description	Purpose
1	Ethernet Port	RMI connection
2	Serial Port	Engineering diagnostics access
3	Controller LED	<ul style="list-style-type: none"> Blinking, OK Not blinking, failed
4	USB Port	Firmware upgrades and key storage

Ethernet Port

The Ethernet port is available on the library controller and connects the library to a network or PC for working remotely with the RMI.

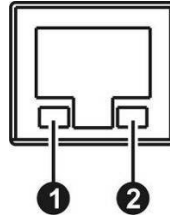

Figure 1-9: FC Half-Height Tape Drives

No.	Description
1	LED (amber) is illuminated when a connection is in place.
2	LED (green) is illuminated when the connection is ready or in use.

User Interfaces

The library has two interfaces:

- **Operator Control Panel (OCP)** – Monitor, configure, and control the library from the library's front panel.
- **Remote Management Interface (RMI)** – Monitor, configure, and control the library remotely with a web browser. The RMI hosts a dedicated, protected internet site that includes a graphical representation of the library.

Default Settings

The following at the defaults set at the factory:

Setting	Library Default
Initial admin password	adm001
Host name	-
Domain name	-
IPv4	Enabled
IPv6	Disabled
DHCP	Disabled
Mailslot configuration	Disabled
Configure reserved slots	Reserved slots = 0
SCSI master drive	The lowest physical drive is initially the LUN master drive.
OCP contrast setting	10
Library Mode	Automatic
Auto load	Disabled
Loop	Disabled

Setting	Library Default
Drive power <ON/OFF>	All drives are powered on
Auto clean	Disabled
SNMP	Disabled
FC tape drives	Automatic speed, auto topology
Log Tracing Configuration	All selected
Email notification	No events
Partitioning <ON/OFF>	Partitioning is turned off

Installation & Configuration

This chapter provides instructions for installing any NEO S-Series Tape Library. Perform the procedures in this chapter in the order they are presented.

NOTE: The library was designed for rack installation in a standard 19-inch rack and must be installed using the provided rack rails. Installation on a table top or other similar surface could result in library operation errors. Select a rack with access to the host server.

Topics in Installation & Configuration:

- [Installation Preparation](#)
- [Unpack and Install the Library](#)
- [Populating the Library with Cartridges](#)

Installation Preparation

Follow these steps to prepare the site for a rack-mounted installation of a NEO S-Series Tape Library.

Location Requirements

Choose a location that meets the following criteria:

Criteria	Definition
Room temperature	10 to 35 °C (50 to 95 °F)
Power source	AC Power Voltage: 100 to 127 VAC; 200-240 VAC Line Frequency: 50 to 60 Hz Place the library near an AC outlet. The AC power cord is the product's main AC disconnect device and must be easily accessible at all times. A surge protector and backup power source is recommended.
Relative humidity	20 to 80% RH non-condensing
Air quality	The library should be placed in an area with minimal sources of particulate contamination. Avoid areas near frequently used doors and walkways, stacks of supplies that collect dust, printers, and smoke-filled rooms. Excessive dust and debris can damage cartridges and the tape drive.
Clearances	<ul style="list-style-type: none"> • Front: Minimum of 30.8cm (12 in.) for Mailslot access and 60cm (24 in.) to remove magazines • Back: Minimum of 15.4cm (6 in.) • Sides: Minimum of 5cm (2 in.)

LUN Scanning

The NEO S-Series Tape Library uses a single SCSI ID per tape drive to control the tape drives. All the drives are a single logical unit (LUN 0) while library robotics is a different logical unit (LUN 1).

To access the different LUNs, the library requires a host bus adapter (HBA) that supports LUN scanning.



IMPORTANT: If LUN scanning is disabled, your host system will not scan beyond LUN 0 and will only see the tape drives and fail to discover the library (LUN 1).

Serial Attached SCSI (SAS) Connections

Serial Attached SCSI (SAS) is a computer bus technology used to transfer data to and from tape drives in the NEO S-Series Tape Library. Mini-SAS is designed to transfer data at up to 6.0 Gigabits per second and mini-SAS HD (LTO-9) to transfer data at up to 12.0 Gigabits per second. Each SAS tape drive in the library has a mini-SAS or mini-SAS HD connector and the connectors are keyed for correct connection.

Most SAS HBA ports have four SAS channels. Each tape drive uses one channel, so each HBA port can support up to four drives using a fan-out cable with four connectors. If you use cables with only one connector on each end, a different channel will be used for each drive.

Fibre Channel Connections

Fibre Channel (FC) allows an active, intelligent interconnection scheme, called a Fabric, to connect devices. The NEO S-Series Tape Library allows the selection of the following three Fibre Channel port behaviors:

- **LN_Port** (default setting) – An automatic configuration that tries an Arbitrated Loop first (L_Port), then a Switched Fabric (N_Port).
- **L_Port** (Loop port) – An Arbitrated Loop topology.
- **N_Port** (Node port) – A point-to-point protocol in a Switched Fabric topology.

The Fibre Channel tape drive can be connected either directly to the server with a HBA or through a storage area network (SAN).

Use the appropriate HBA for your tape drive to meet performance requirements. A lower Gbps HBA may result in performance degradation when moving highly compressible data to a higher Gbps tape drive.

In a SAN installation, all switches between the host and the library must be of the appropriate type. A lower Gbps switch in the path may result in performance degradation. Configure zoning so only the backup servers can access the library.

Host Preparation

Follow these general guidelines:

- Make sure that your backup application supports the selected HBA and tape drive interface type HBA.
- If the host server is connected to a network, check with your system administrator before powering it off.
- Install a suitably rated HBA.

Installation Precautions



WARNING: Before moving or lifting a library:

- Observe local health and safety requirements and guidelines for manual material handling.
- Remove all tape cartridges to reduce the weight and to prevent cartridges from falling into the robotics path and damaging the library.
- Obtain adequate assistance to lift and stabilize the library during installation or removal.



CAUTION: When placing a library into or removing the library from a rack:

- Extend the rack's leveling jacks to the floor.
- Ensure that the full weight of the rack rests on the leveling jacks.
- Install stabilizing feet on the rack.
- Extend only one rack component at a time.

Other items to be observed:

- Do not expose the library to moisture.
- Use the library on a firm level surface free from vibration.
- Do not place anything on top of the library.
- Do not turn the library on its sides or ends.

Unpack and Install the Library



CAUTION: If the temperature in the room where the library will operate varies by 15°C (30°F) from where the module was stored, allow it to acclimate for at least 12 hours prior to unpacking.

Follow the Quick Start Guide instructions that came packed with the appliance. It covers the unpacking, rail installation, and cable connections of the tape library.

The Quick Start Guide is also available as a PDF online from the Overland-Tandberg Knowledge Base at:

<https://www.overlandtandberg.com/knowledgebase/>

Once installed, press the power button on the front bezel to power on the NEO S-Series Tape Library. The powering up can take a few minutes as it includes scanning the inventory and configuration.

Populating the Library with Cartridges

NOTE: Refer to Chapter 3, "Media and Magazines," for information regarding the media available for use in your NEO S-Series Tape Library.

The NEO S-Series Tape Library uses removable magazines to store the tape cartridges. These can be removed for easy loading to populate the library.

NOTE: Should the normal OCP or RMI release process fail, a manual release is available. See Manual Magazine Release on page 35 of Chapter 3, "Media and Magazines," for details.

Use either the OCP or the RMI to release the magazines for extraction:

- **OCP – Commands > Unlock Magazines**
- **RMI – Move Media > Inventory > Magazines > Release Magazine**

Media and Magazines

The NEO S-Series Tape Library uses removable magazines to store the tape cartridge media. This chapter explains which media to use with your library, and how to label and write-protect your tape cartridges. Careful labeling and handling of the tape cartridges will prolong the life of the tape cartridges and the library.

The chapter also addresses tape magazines that can be removed and inserted individually. These magazines are locked to prevent unauthorized removal when inserted in the library and unlocked access can be password protected. For safety reasons, the robotic motion is stopped whenever when a magazine is either removed from the library physically or the mailslot access is activated.

Should the normal OCP or RMI release process fail, a manual release is available. See [Manual Magazine Release on page 35](#) for details.

Topics in Media and Magazines:

- [LTO Ultrium Data Cartridge](#)
 - [Tape Cartridge Barcode Labels](#)
 - [Write Protecting Tape Cartridges](#)
 - [LTO Cartridge Capacities](#)
 - [LTO Read and Write Compatibility](#)
 - [LTO-9 Cartridge Initialization](#)
 - [Write Once, Read Many \(WORM\)](#)
 - [Cleaning Cartridge](#)
 - [Cartridge Care and Handling](#)
 - [Environmental and Shipping Specifications for Tape Cartridges](#)
 - [Disposing of Tape Cartridges](#)
- [Tape Magazines](#)
 - [Slot Numbering](#)
 - [Mailslots](#)
 - [Manual Magazine Release](#)

LTO Ultrium Data Cartridge

This figure shows the LTO Ultrium data cartridge and its components:

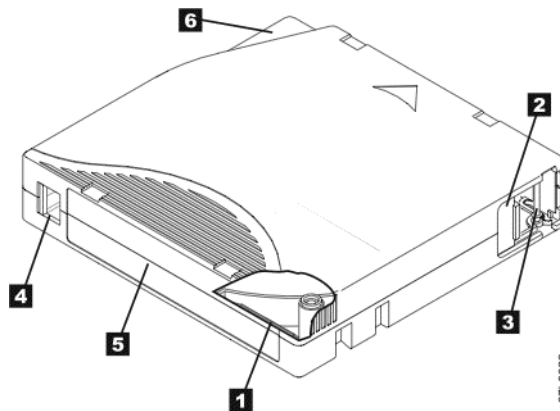

Figure 3-1: LTO Cartridge Components

No.	Description
1	LTO Cartridge Memory (inside)
2	Cartridge Door
3	Leader Pin
4	Write-protect Switch
5	Barcode Label Area
6	Insertion Guide Notch

The cartridge door (2) protects the tape from contamination when the cartridge is out of the drive. The tape is attached to a leader pin (3), behind the door. When the cartridge is inserted into the drive, a threading mechanism pulls the pin (and tape) out of the cartridge, across the drive head, and onto a non-removable take-up reel. The head can then read or write data from or to the tape.

The write-protect switch (4) prevents data from being written to the tape cartridge.

Tape Cartridge Barcode Labels

The device contains a barcode reader that reads the tape labels and stores the inventory data in memory. The device then provides the inventory information to the host application, OCP, and RMI. Having a barcode label on each tape cartridge enables the barcode reader to identify the cartridge quickly, thereby speeding up inventory time. Make it a practice to always use barcode labels on your tape cartridges.

Your host software may need to keep track of the following information via the associated barcode:

- Date of format or initialization
- Tape's media pool
- Data residing on the tape
- Age of the backup
- Errors encountered while using the tape (to determine if the tape is faulty)

NOTE: The misuse and misunderstanding of barcode technology can result in backup and restore failures. To ensure that your barcodes meet manufactures quality standards, always purchase them from an approved supplier and never print barcode labels yourself.

LTO tape cartridges have a recessed area located on the face of the cartridge next to the write-protect switch. Use this area for attaching the adhesive-backed barcode label. Only apply labels as shown here:

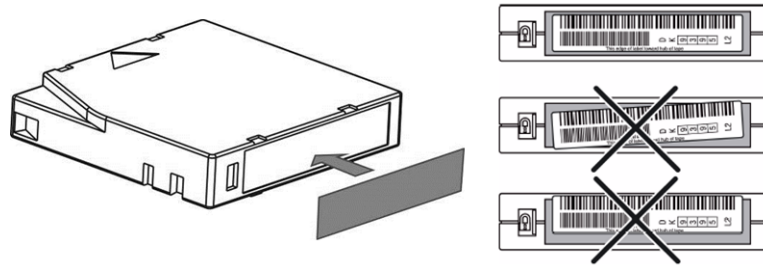

Figure 3-2: Apply Barcode Label to LTO Tape Cartridge

NOTE: The barcode label should only be applied with the alphanumeric portion facing to the left-side of the tape (toward the write protect switch) and within the marked Barcode label area. Never apply multiple labels onto a cartridge as extra labels can cause the cartridge to jam in a tape drive.

Guidelines for Using Barcode Labels

Apply the following guidelines whenever using barcode labels:

- Use only Overland-approved barcode labels on cartridges to be used in a NEO Series tape library.
- Do not reuse a label or reapply a used label over an existing label.
- Before you apply a new label, remove the old label by slowly pulling it at a right angle to the cartridge case.
- Use peel-clean labels that do not leave a residue after being removed. If there is glue residue on the cartridge, remove it by gently rubbing it with your finger. Do not use a sharp object, water, or a chemical to clean the label area.
- Examine the label before applying it to the cartridge. Do not use the label if it has voids or smears in the printed characters or barcode (a library's inventory operation will take much longer if the barcode label is not readable).
- Remove the label from the label sheet carefully. Do not stretch the label or cause the edges to curl.
- Position the label within the recessed label area.
- With light finger pressure, smooth the label so that no wrinkles or bubbles exist on its surface.
- Verify that the label is smooth and parallel, and has no roll-up or roll-over. The label must be flat to within 0.5 mm (0.02 in.) over the length of the label and have no folds, missing pieces, or smudges.
- Do not place other machine-readable labels on other surfaces of the cartridge. They may interfere with the ability of the drive to load the cartridge.

Write Protecting Tape Cartridges

All rewritable data cartridges have a write-protect switch to prevent accidental erasure or overwriting of data. Before loading a cartridge into the device, make sure the write-protect switch on the front of the cartridge is in the desired position:

- Slide the switch to the **left** to allow the device to write data to the cartridge.
- Slide the switch to the **right** to write protect the cartridge.

An indicator, such as a red mark or small padlock, is visible showing that the cartridge is write-protected.

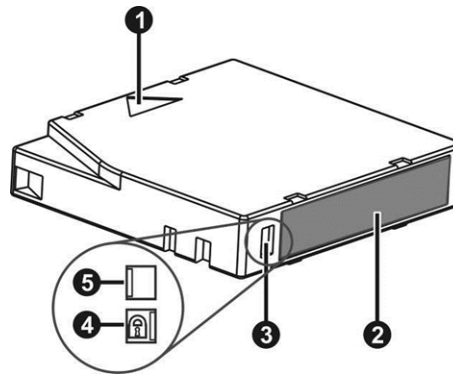

Figure 3-3: Write Protecting a Cartridge

No.	Description
1	Molded Insertion Arrow
2	Barcode Label
3	Write-Protect Switch
4	Write Protected Position (Lock Symbol)
5	Write-Enabled Position

LTO Cartridge Capacities

When processing tape in the cartridges, LTO Ultrium Tape Drives use a linear, serpentine recording format. The native data capacity and recording format of LTO Ultrium data cartridges is as follows:

Type	Native Data Capacity	Compressed Data Capacity
Ultrium 9	18.0 TB	45.0 TB (at 2.5:1 compression)
Ultrium 8	12.0 TB	30.0 TB (at 2.5:1 compression)
Ultrium 7 Type M*	9.0 TB	22.5 TB at 2.5:1 compression)
Ultrium 7	6.0 TB	15.0 TB at 2.5:1 compression)
Ultrium 6	2.5 TB	6.25 TB at 2.5:1 compression)
Ultrium 5	1.5 TB	3.0 TB at 2:1 compression)

* Special LTO-7 cartridge for use in an LTO-8 drive.

The first set of tracks is written from near the beginning of the tape to near the end of the tape. The head then repositions to the next set of tracks for the return pass. This process continues until all tracks are written and the cartridge is full, or until all data is written.

LTO Read and Write Compatibility

Media Type	LTO-6 Drive	LTO-7 Drive	LTO-8 Drive	LTO-9 Drive
LTO-6 Media, Unencrypted	Read/Write	Read/Write	Incompatible	Incompatible
LTO-6 Media, Encrypted	Read/Write with encryption key	Read/Write with encryption key	Incompatible	Incompatible
LTO-7 Media, Unencrypted	Incompatible	Read/Write	Read/Write	Incompatible
LTO-7 Media, Encrypted	Incompatible	Read/Write with encryption key	Read/Write with encryption key	Incompatible
LTO-7 Type M Media, Unencrypted	Incompatible	Incompatible	Read/Write	Incompatible
LTO-7 Type M Media, Encrypted	Incompatible	Incompatible	Read/Write with encryption key	Incompatible
LTO-8 Media, Unencrypted	Incompatible	Incompatible	Read/Write	Read/Write
LTO-8 Media, Encrypted	Incompatible	Incompatible	Read/Write with encryption key	Read/Write with encryption key
LTO-9 Media, Unencrypted	Incompatible	Incompatible	Incompatible	Read/Write
LTO-9 Media, Encrypted	Incompatible	Incompatible	Incompatible	Read/Write with encryption key

LTO-9 Cartridge Initialization

New LTO-9 cartridges need to be initialized before they can be used because the increased number of tracks used to write data on an LTO-9 tape requires greater precision. Media optimization creates a referenced calibration for each cartridge that enables the tape drive's intelligent alignment to optimize data placement. LTO-9 media optimization enhances LTO tape long-term media durability.

- Media optimization is performed on first load of LTO-9 media during initialization.
- Media optimization is a one-time operation that can be completed on any drive in the environment, enabling the media to be used across all tape drives without further optimization.
- Media optimization averages 40 minutes per first load of a cartridge to a tape drive. Although most media optimizations will complete within 60 minutes, some media optimizations may take up to 2 hours.
- Interruption of the process is not recommended.
- During cartridge initialization, the Single Character display will show a lowercase “c” (calibrating).

Technical briefs covering the LTO-9 new media initialization for either a XL-Series or S-Series library can be found in the Overland-Tandberg Knowledge Base under *Tape Archive Solutions (NEO & LTO Drives)*. See the *NEO & LTO Technical Bulletins & FAQs* section.

<https://www.overlandtandberg.com/knowledgebase/>

Write Once, Read Many (WORM)

Certain records retention and data security applications require a Write Once, Read Many (WORM) method for storing data on tape. The LTO Ultrium tape drives enable WORM support when a WORM tape cartridge is loaded into the drive.

WORM Media

Because standard read/write media are incompatible with the WORM feature, a specially formatted WORM tape cartridge is required.

Each WORM cartridge has a unique, worldwide cartridge identifier (WWCID), which comprises the unique CM chip serial number and the unique tape media serial number.

Data Security on WORM Media

Certain built-in security measures help ensure that the data written on a WORM cartridge does not become compromised, for example:

- The format of an Ultrium 6 (3000 GB), Ultrium 7 (9000 GB), Ultrium 8 (12000 GB), or Ultrium 9 (18000 GB) WORM Tape Cartridge is unlike that of standard read/write media. This unique format prevents a drive that lacks WORM-capable firmware from writing on a WORM tape cartridge.
- When the drive senses a WORM cartridge, the firmware prohibits the changing or altering of user data already written on the tape. The firmware keeps track of the last appendable point on the tape.

WORM Media Errors

The following conditions cause WORM media errors to occur:

- Information in the servo manufacturer's word (SMW) on the tape must match information from the cartridge memory (CM) module in the cartridge. If it does not match, a media Error Code 7 will post on the drive's single-character display (SCD). An error will also be displayed on the Operator Control Panel.

Inserting a WORM tape cartridge into a drive that is not WORM capable causes the cartridge to be treated as an unsupported medium. The drive will report a media Error Code 7. Upgrading the drive firmware to the correct code level will resolve the problem. See <http://docs.overlandstorage.com/neo>.

Requirements for WORM Capability

To use the WORM capability of your LTO Ultrium tape drive, you need to use a compatible WORM tape cartridge.

Cleaning Cartridge

An Ultrium Universal Cleaning Cartridge is required to clean the tape drive. The drive itself determines when it needs to be cleaned and notifies the library. When notified, the library indicates that the drive needs cleaning by turning ON the "Clean Drive" LED on the front panel of the library and posting a message on the library display.

A tape drive within a library requires the use of a library menu function to either automatically or manually clean the tape drive. See [Chapter 5, "Remote Management Interface."](#)



IMPORTANT: It is recommended that the drive be cleaned only when it is requested by the drive firmware.

The Ultrium Universal Cleaning Cartridge is valid for 50 uses. The cartridge's LTO-CM (Cartridge Memory) chip tracks the number of times that the cartridge is used. For details, refer to the [LTO External Drives and Media](#) page on the Overland-Tandberg website.

NOTE: The drive will automatically eject an expired cleaning cartridge.

Cartridge Care and Handling

NOTE: Do not insert a damaged tape cartridge into the drive. A damaged cartridge can interfere with the reliability of a drive and may void the warranties of the drive and the cartridge. Before inserting a tape cartridge, inspect the cartridge case, cartridge door, and write-protect switch for breaks.

Incorrect handling or an incorrect environment can damage cartridges or their magnetic tape. To avoid damage to your tape cartridges and to ensure the continued high reliability of your LTO Ultrium Tape Drives, use the guidelines in the following sections.

Provide Training

- Post procedures that describe proper media handling in places where people gather.
- Ensure that anyone who handles tape has been properly trained in handling and shipping procedures. This includes operators, users, programmers, archival services, and shipping personnel.
- Ensure that any service or contract personnel who perform archiving are properly trained in media-handling procedures.
- Include media-handling procedures as part of any services contract.
- Define and make personnel aware of data recovery procedures.

Ensure Proper Packaging

- When shipping a cartridge, use the original or better packaging.
- Always ship or store a cartridge in a jewel case.
- Use only a recommended shipping container that securely holds the cartridge in its jewel case during transportation. Ultrium Turtlecases (by Perm-A-Store) have been tested and found to be satisfactory. They are available at www.turtlecase.com.



Figure 3-4: Ultrium Turtlecase (by Perm-A-Store) Shipping Container

- Never ship a cartridge in a commercial shipping envelope. Always place it in a box or package.
- If you ship the cartridge in a cardboard box or a box of a sturdy material, ensure the following:
 - Place the cartridge in polyethylene plastic wrap or bags to protect it from dust, moisture, and other contaminants.
 - Pack the cartridge snugly; do not allow it to move around.
 - Double-box the cartridge (place it inside a box, then place that box inside the shipping box) and add padding between the two boxes.



Figure 3-5: Double-boxed with Additional Padding

Provide Proper Acclimation and Environmental Conditions

- Before you use a tape cartridge, acclimate it to the operating environment for 24 hours or the time necessary to prevent condensation in the drive (the time will vary, depending on the environmental extremes to which the cartridge was exposed).
- Ensure that all surfaces of a cartridge are dry before inserting it.
- Do not expose the cartridge to moisture or direct sunlight.
- Do not expose recorded or blank cartridges to stray magnetic fields of greater than 100 Oersted (for example, terminals, motors, video equipment, X-ray equipment, or fields that exist near high-current cables or power supplies). Such exposure can cause the loss of recorded data or make the blank cartridge unusable.

- Maintain the conditions that are described in “[Environmental and Shipping Specifications for Tape Cartridges](#)” on page 33.

Perform a Thorough Inspection

After purchasing a cartridge and before using it, perform the following steps:

Inspect the cartridge's packaging to determine potential rough handling.

When inspecting a cartridge, open only the cartridge door. Do not open any other part of the cartridge case. The upper and lower parts of the case are held together with screws; separating them destroys the usefulness of the cartridge.

Inspect the cartridge for damage before using or storing it.

Inspect the rear of the cartridge (the part that loads first into the tape load compartment) and ensure that there are no gaps in the seam of the cartridge case (1). If there are gaps in the seam, the leader pin may be dislodged.

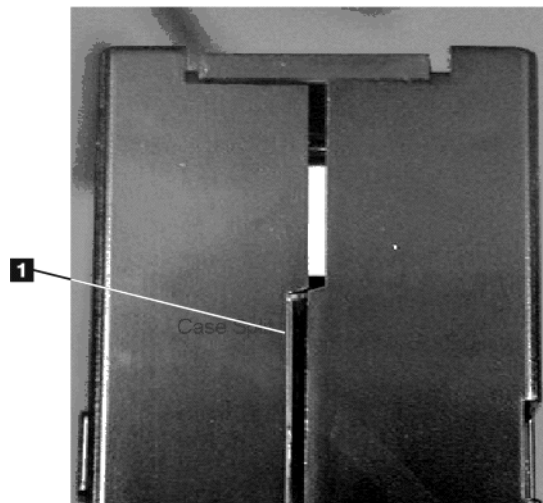

Figure 3-6: Close-up of Cartridge with Seam Gap

- Check that the leader pin is properly seated (2).

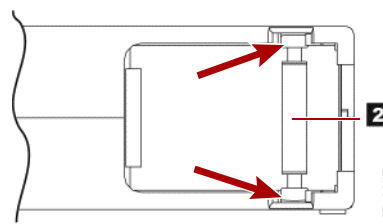

Figure 3-7: Leader Pin Properly Seated

- If you suspect that the cartridge has been mishandled but it appears usable, copy any data onto a good cartridge immediately for possible data recovery. Discard the mishandled cartridge.
- Review handling and shipping procedures.

Handle the Cartridge Carefully

- Do not drop the cartridge. If the cartridge drops, slide the cartridge door back and ensure that the leader pin (1) is properly seated in the pin-retaining spring clips.

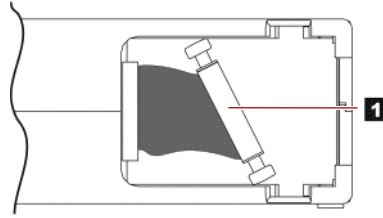

Figure 3-8: Leader Pin Not Seated Properly

- Do not handle tape that is outside the cartridge. Handling the tape can damage the tape's surface or edges, which may interfere with read or write reliability. Pulling on tape that is outside the cartridge can damage the tape and the brake mechanism in the cartridge.
- Do not stack more than six cartridges.
- Do not degauss a cartridge that you intend to reuse. Degaussing makes the tape unusable.

Environmental and Shipping Specifications for Tape Cartridges

Before you use a tape cartridge, acclimate it to the operating environment for 24 hours or the time necessary to prevent condensation in the drive (the time will vary, depending on the environmental extremes to which the cartridge was exposed).

The best storage container for the cartridges (until they are opened) is the original shipping container. The plastic wrapping prevents dirt from accumulating on the cartridges and partially protects them from humidity changes.

When you ship a cartridge, place it in its jewel case or in a sealed, moisture-proof bag to protect it from moisture, contaminants, and physical damage. Ship the cartridge in a shipping container that has enough packing material to cushion the cartridge and prevent it from moving within the container.

The following table gives the environment for operating, storing, and shipping LTO Ultrium Tape Cartridges.

Environmental Factor	Environmental Specifications			
	Operating	Operational Storage*	Archival Storage†	Shipping
Temperature	10 to 45 °C (50 to 113 °F)	16 to 32 °C (61 to 90 °F)	16 to 25 °C (61 to 77 °F)	-23 to 49 °C (-9 to 120 °F)
Relative humidity (non-condensing)	10 to 80%	20 to 80%	20 to 50%	5 to 80%
Maximum wet bulb temperature	26 °C (79 °F)	26 °C (79 °F)	26 °C (79 °F)	26 °C (79 °F)

* The short term or operational storage environment is for storage durations of up to six months.

† The long term or archival storage environment is for durations of six months up to ten years.

Disposing of Tape Cartridges

Under the current rules of the U.S. Environmental Protection Agency (EPA), regulation 40CFR261, the LTO Ultrium Tape Cartridge is classified as non-hazardous waste. As such, it may be disposed of in the same way as normal office trash. These regulations are amended from time to time, and you should review them at the time of disposal.

If your local, state, country (non-U.S.A.), or regional regulations are more restrictive than EPA 40CFR261, you must review them before you dispose of a cartridge. Contact your account representative for information about the materials that are in the cartridge.

If a tape cartridge must be disposed of in a secure manner, you can erase the data on the cartridge by using a high-energy AC degausser (use a minimum of 4000 Oersted peak field over the entire space that the cartridge occupies). The tape should make two passes through the field at 90 degree orientation change for each pass to achieve complete erasure and make the cartridge unusable.

NOTE: Some commercial degaussers have two magnetic field regions offset 90 degrees from each other to accomplish complete erasure in one pass for higher throughput.

If you burn the cartridge and tape, ensure that the incineration complies with all applicable regulations.

Tape Magazines

The NEO S-Series Tape Library makes use of removable magazines in each model. Tape cartridges are stored in magazines. Magazines may be removed and inserted individually. Magazines are locked to prevent unauthorized removal when inserted in the library and unlock Magazine access may become password protected. For safety reasons, the robotic motion is stopped whenever when a magazine is removed from the library.

The magazines can be unlocked using the Operator Control Panel (OCP) or the Remote Management Interface (RMI). For the OCP, see either [NEOs StorageLoader Commands Menu on page 42](#) or [NEOs T24 Library Commands Menu on page 49](#). For the RMI, see [Chapter 5, "Magazines," on page 70](#).

In case the OCP or RMI initiated process has failed or the library no longer has power a manual emergency release is available, see [Manual Magazine Release](#) below.

Slot Numbering

The following graphics detail the slot numbering in the different libraries. A number with an asterisk (*) and **red circle** around it indicates a mailslot.

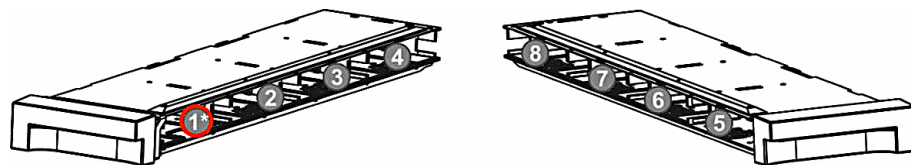

Figure 3-9: Slot Numbering Scheme (1U)

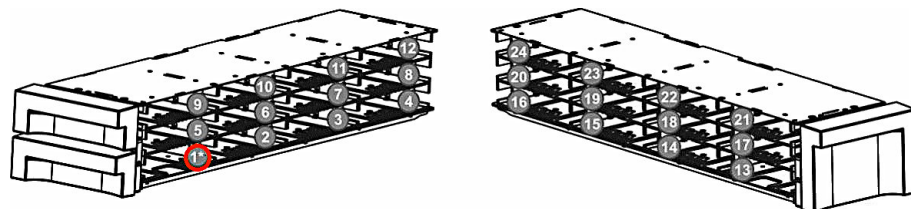

Figure 3-10: Slot Numbering Scheme (2U) - Single Mailslot

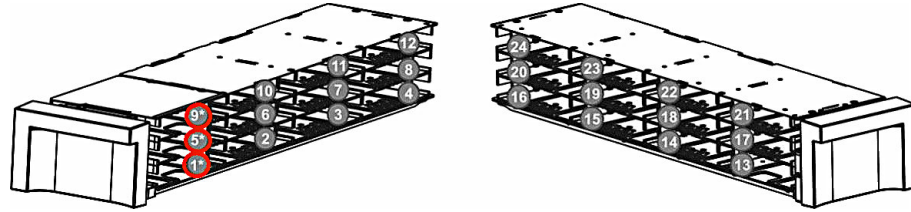

Figure 3-11: Slot Numbering Scheme (2U) - Triple Mailslot

Mailslots

Mailslots are used to import/export individual tape cartridges without interrupting the library operation. The command to open the mailslot may be denied if the robotics is busy with some operation. In that case, “Busy” is displayed on the OCP and the command has to be repeated once the robotics operation is finished.

- The 1U library provides a single mailslot (slot 1) in the bottom left position.
- The 2U library provides a single mailslot (slot 1) or an optional triple-mailslot magazine (slots 1,5, and 9) in the bottom left position.

When released, library access to the 1U or 2U (Single Mailslot) is prevented allowing the entire magazine to slide out just enough to access the mailslot. Pushing the magazine back in reactivates the access to that magazine.

For the optional 2U triple-mailslot, when released, the front mailslot section of the magazine can be opened without the remainder of the magazine moving thus allowing the rear slots to continue to be used by the library while the mailslots are used.

Manual Magazine Release

If you are unable to remove the tape magazines using the OCP or RMU, do the following:

1. Press the power button on the front bezel to power down the library.
2. Unplug the power cord from the library.
3. From the rear panel of the library, find the access holes for the right and left magazines located at the lower corners of the bottom tape drive.

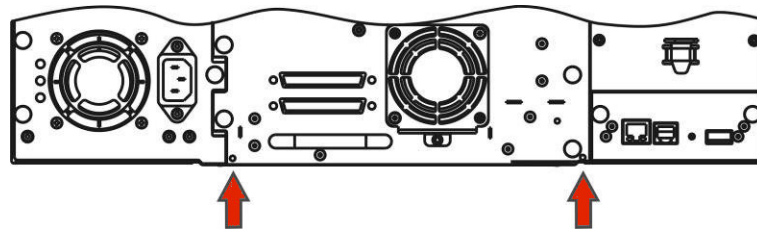

Figure 3-12: Rear Panel Manual Release Access Holes

4. Push the end of a small metal pin or straightened paper clip into the magazine access hole at the back of the device to release the magazine.
5. While the pin or clip is pressed in, have a second person pull the magazine out at the front of the unit.

Operator Control Panel

The Operator Control Panel (OCP) refers to the front panel of the library and consists of an LCD display, navigation buttons, operation buttons, LEDs, and a USB port. With the OCP, you can monitor, configure, and operate most library functions.

Topics in Operator Control Panel:

- [Overview](#)
- [Power-Up Display](#)
- [OCP LEDs](#)
- [Input Modes](#)
- [Power ON/OFF](#)
- [Menu Flowcharts](#)

Overview

For details on the OCP layouts based on the different libraries, see the [Front Panel on page 13](#) in [Chapter 1, “Product Overview.”](#)

Operation Modes

There are two types of OCP modes:

- **User Interaction Mode**
This mode is employed when a user is pushing buttons on the OCP.
- **System Driven Mode**
This is the normal mode of operation. In this mode, the operating panel displays status associated with the actions that were caused from commands issued from the host software application. Actions like loading, rewinding or moving tape cartridges will be displayed.

Whenever an operating button is pressed and released, the OCP automatically transitions to User Interaction Mode. The User Interaction Mode is active until three minutes after the user stops pushing buttons or the requested robotic action stops – whichever is longer. At this time, the operating panel returns to the System Driven Mode.

In the case of administrator-programed user security feature, the User Interaction Mode is restricted to the information and login menu item until a login with the correct PIN is done.

OCP Rules

OCP operation must obey some basic rules. These rules of operation constitute a philosophy:

- Any operational conflict between commands received over SCSI or RMI and those entered via the front panel is avoided with a reservation mechanism of a “first-come, first-served” basis.
Any reservation by OCP is canceled by an OCP logout or the timeout, which cancels the User Interaction Mode.
- The library firmware will not allow a user to select an impossible request. Those situations will include, but are not limited to:
 - Moving a tape cartridge from any source to a full magazine slot
 - Moving a tape cartridge from an empty magazine slot
 - Loading a tape cartridge from any source to a full tape drive
 - Unloading a tape cartridge from an empty tape drive
- Any error detected by the library or drive controller and not recoverable through predetermined firmware algorithms will be considered as fatal. An error code will be displayed on the LCD and the error LED will become illuminated. The error code will remain on the OCP until a push button is pressed, which will cause the OCP to return to the home screen.
- Numeric error codes are only used for unrecoverable, fatal errors (refer to [Appendix B, “Error Codes”](#)), otherwise text status messages are provided.
- In case the OCP or RMI initiated process has failed or the library no longer has power a manual emergency release is available (see [Chapter 3, “Manual Magazine Release”](#)).

Power-Up Display

When the library powers up or resets, it goes through several internally-controlled processes that initialize and prepare the unit for normal operation. These processes are called Power-On Self-Test (POST). While the POST is in process, the OCP displays the appropriate information to keep the user informed. When the library finishes POST, it displays the current library status for a defined time or until a front panel key is pressed.

After this initial status screen, the home screen is displayed until any key is pressed. This home screen shows the overall health of the library, indicating the status of the robotics and the connected drives.

OCP LEDs

All LEDs are updated during power-up and reset sequences. Upon power up or after a reset, the library illuminates all LEDs as soon as POST allows. This helps the user to verify that all LEDs are functional. When initialization starts, all LEDs are extinguished and the Ready/Activity LED flashes at a rate of approximately 1-second per cycle, 50% duty cycle. When the robot mechanical initialization is complete, the Ready/Activity LED stops flashing and is constantly illuminated. The magazine status LEDs also show the appropriate status (locked, unlocked, or removed).

If a library failure occurs, the Ready/Activity LED will be turned off and the error LED will be illuminated. The OCP will also display an appropriate error code to help identify the failure.

The following are additional operational details of LEDs.

- The Ready/Activity LED is lit any time the unit is powered on and functional (for example, successfully completion of the POST). The LED blinks whenever there is any library or drive activity. The LED also blinks when the unit is offline.
- The Clean LED is only lit when a cleaning-required status has been issued by one of the drives. The LED is turned off after a successful drive cleaning operation is performed on the requesting drive.
- The Media Attention LED indicates that there is an LTO media which is bad, marginal, or invalid. The LED is cleared when all marginal and invalid cartridges have been exported from the tape library.
- The Error LED is lit when there is an unrecoverable (hard) library or drive failure. This occurs simultaneously with the hard error message is displayed on the screen. The LED remains illuminated until the error state is resolved.

Input Modes

There are several modes to enter values in the different menus. These values are selectable predefined values, toggle values (on/off), and numerical values like network addresses.

Selectable Predefined Values

After navigating to the menu item, the various predefined values can be selected with the UP and DOWN button. As soon as the display shows the correct value, it may be confirmed by pressing the ENTER button.

Toggle Values

Toggle values are used to switch between two different states like on and off. After navigating to the menu item the display shows the actual state. Pressing the ENTER button will switch to the possible new state. Pressing ENTER button a second time will take over this new state.

Numerical Values

Numerical values are needed for network addresses, PIN entries, and other configuration entries. After navigating to the menu item to be changed, the actual value will be displayed and the cursor stays on the first digit. The value may be incremented / decremented with the UP and DOWN button. After pressing the ENTER button the cursor is set to the next editable digit. It can be changed in the same way. After pressing the ENTER button at the last digit the complete entry will be stored. Pressing the CANCEL button will cancel the whole edit process and the old value is valid again.

Power ON/OFF

The operator control panel contains the power ON/OFF button. Pressing this button initiates a controlled power down of the library (soft landing). Once the power button is pushed from a power on state, the following operations take place before the unit shuts down completely:

- The display indicates with an appropriate message that the shutdown is in progress and provides the opportunity to abort the shutdown by pushing the CANCEL button within three (3) seconds.
- The library controller finishes all ongoing library and drive activities.

- The robotics is moved to its home position.
- The library controller switches off the power supply's secondary side.

Menu Flowcharts

Use the UP, DOWN, and ENTER buttons to move through the menus. The NEOs StorageLoader (1U) has a different set of menu items from the NEOs T24 (2U) tape library.

NEOs StorageLoader (1U) Menu

NOTE: Boxes in red indicate that a PIN is required for access to that command. Blue text shows an example of what may be on the screen.

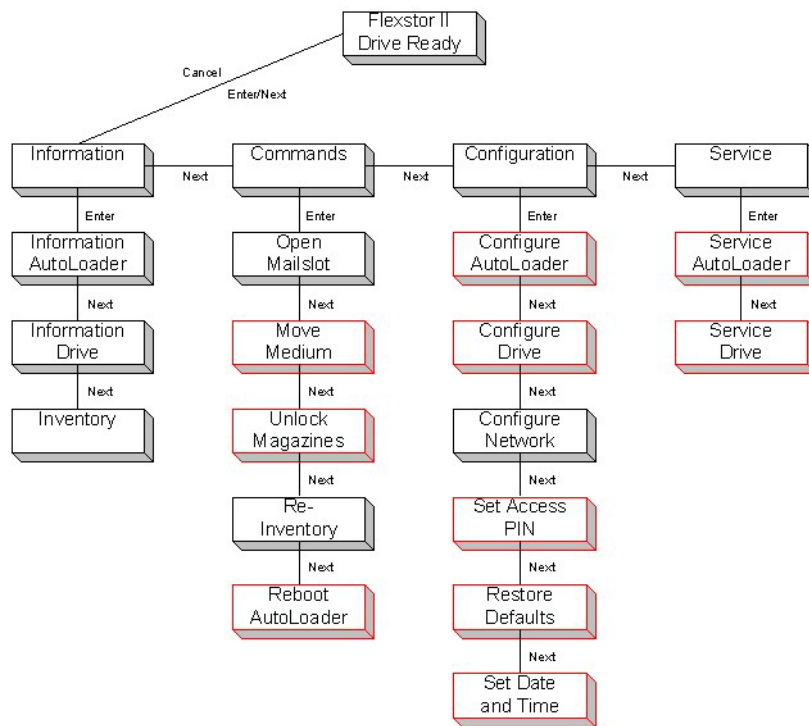

Figure 4-1: NEOs StorageLoader Main Menu

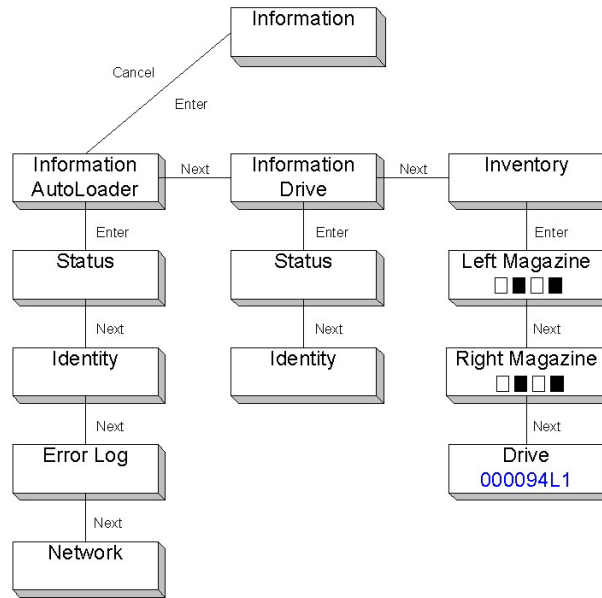
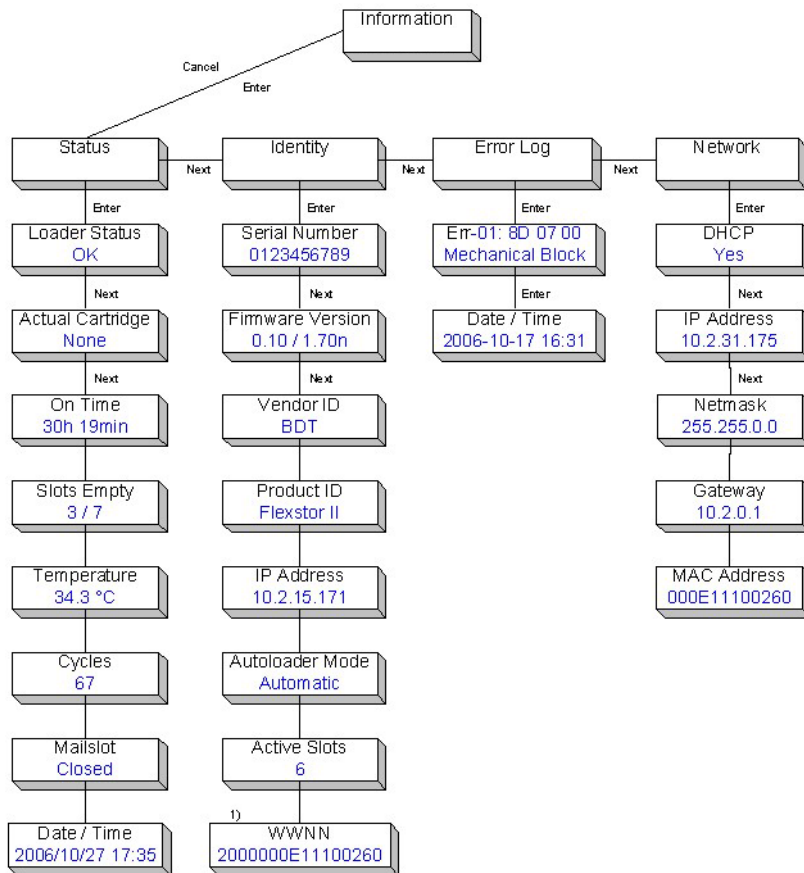

Figure 4-2: NEOs StorageLoader Information Menu



1) menu entries only displayed if a fiber channel drive was found

Figure 4-3: NEOs StorageLoader Library Information Menu

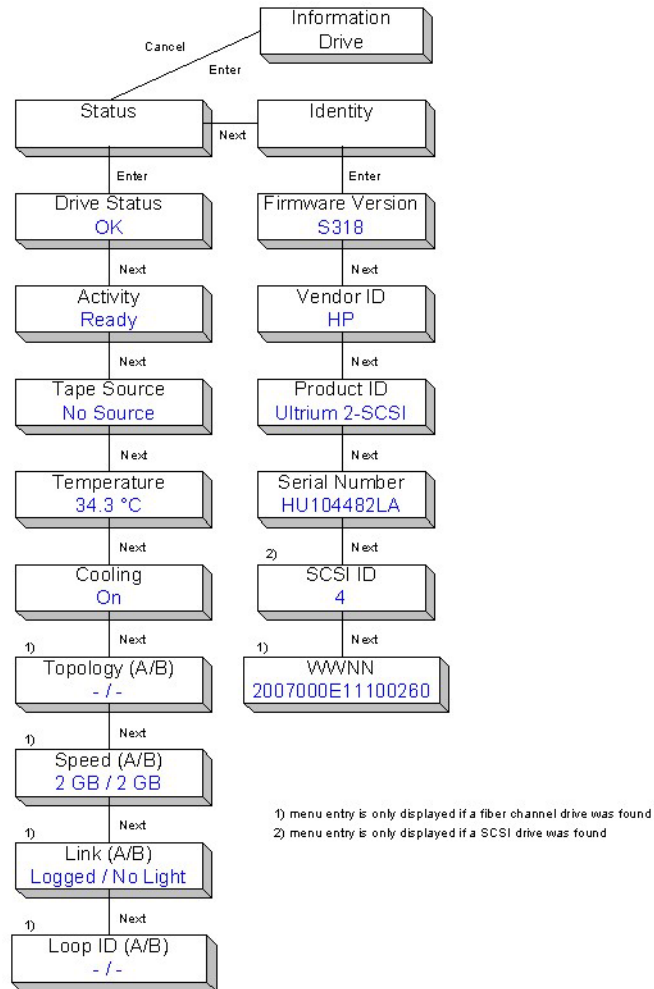

Figure 4-4: NEOs StorageLoader Drive Information Menu

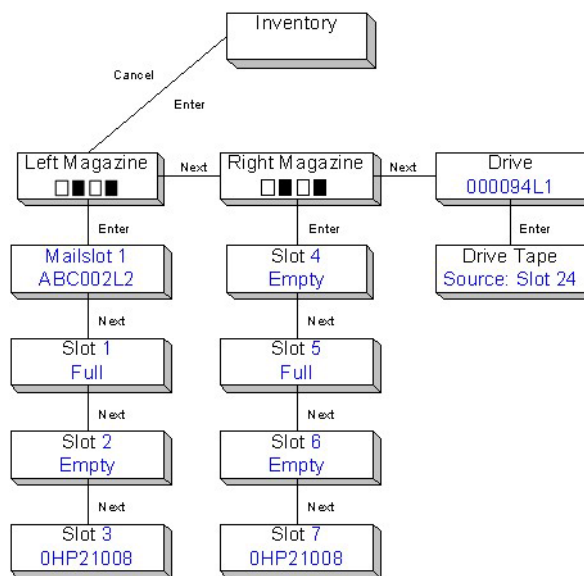

Figure 4-5: NEOs StorageLoader Inventory Menu

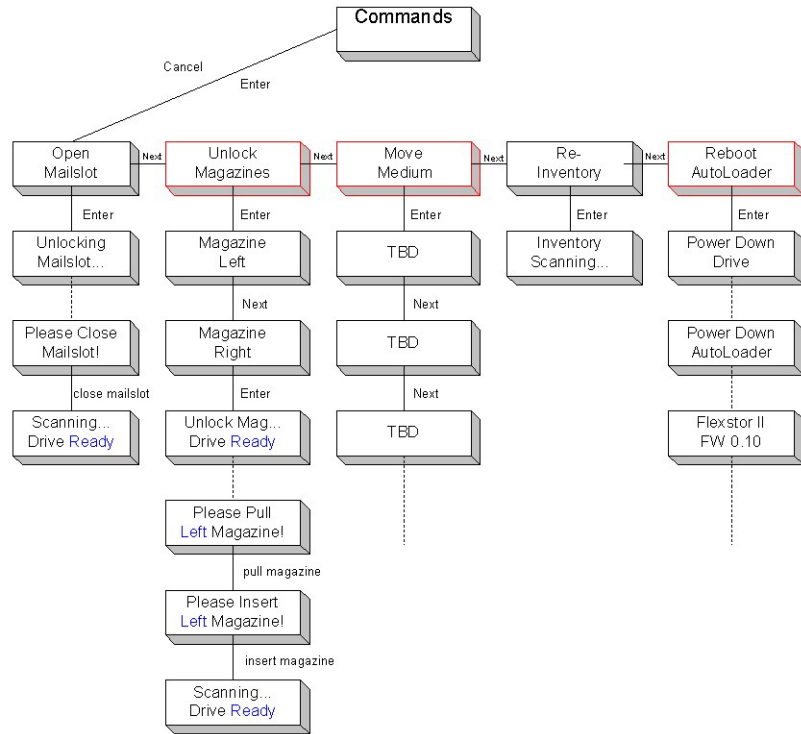
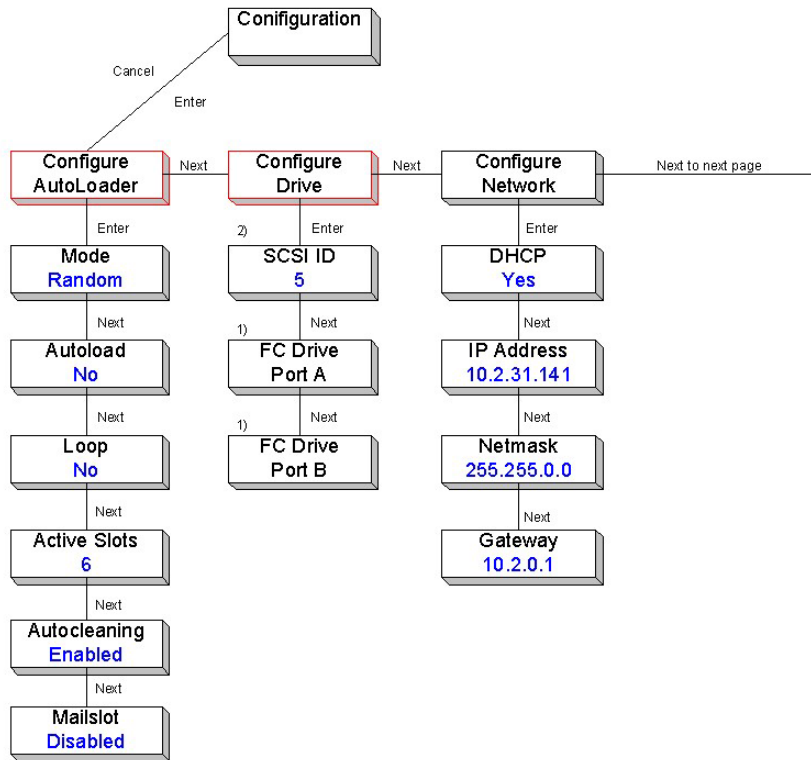

Figure 4-6: NEOs StorageLoader Commands Menu



1) menu entry is only displayed if a fiber channel drive was found
 2) menu entry is only displayed if a SCSI drive was found

Figure 4-7: NEOs StorageLoader Configuration Menu (Part 1)

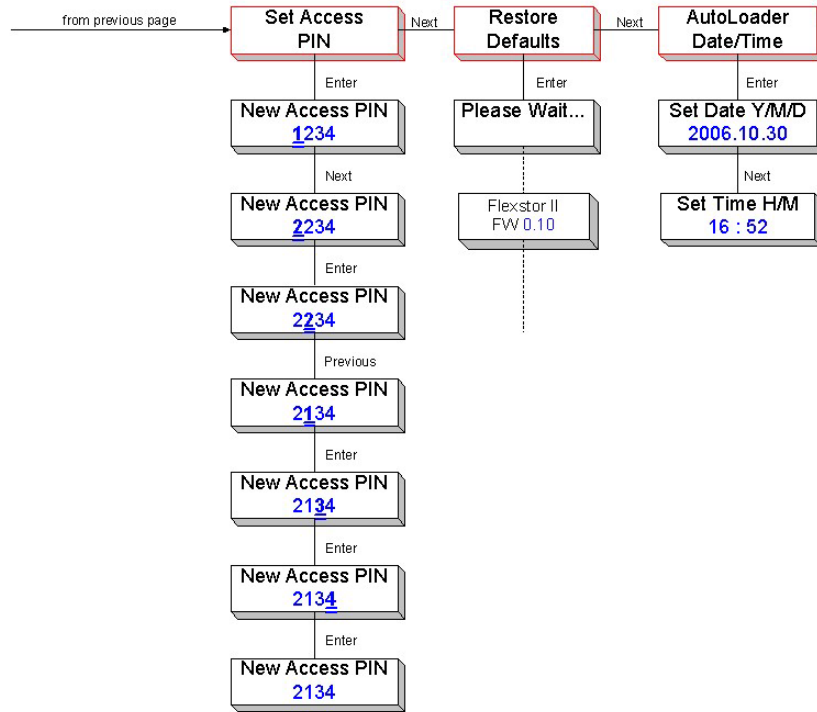

Figure 4-8: NEOs StorageLoader Configuration Menu (Part 2)

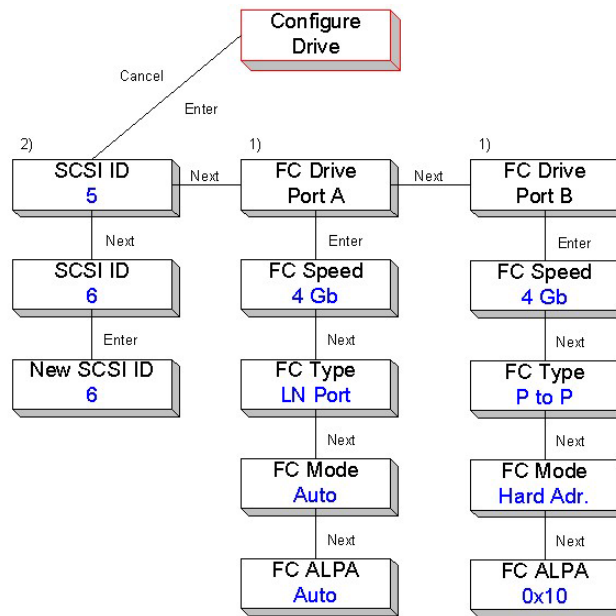

Figure 4-9: NEOs StorageLoader Drive Configuration Menu

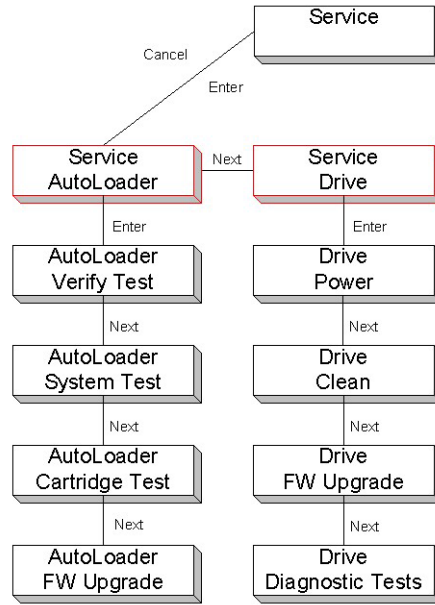
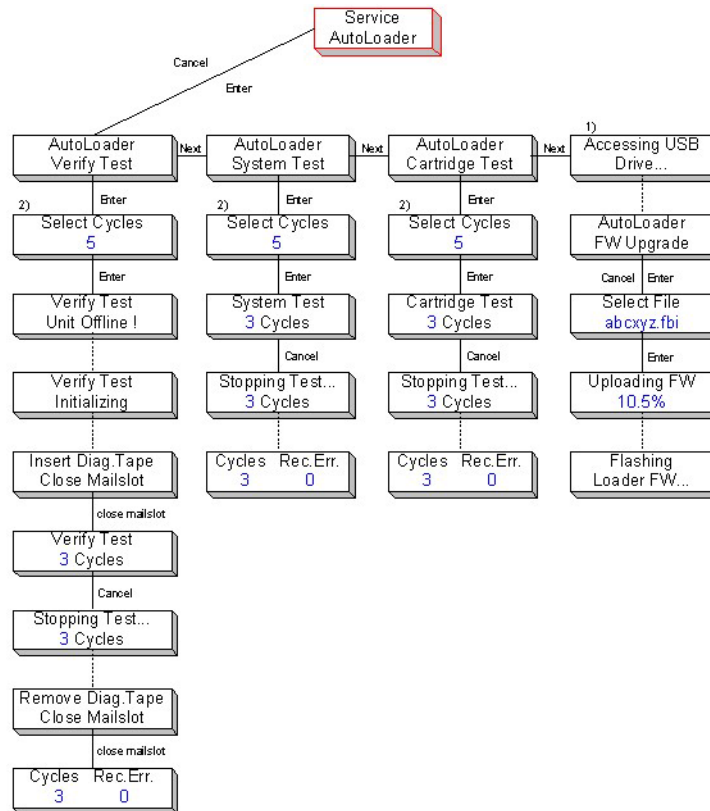

Figure 4-10: NEOs StorageLoader Service Menu



1) menu entry is displayed if a USB drive was found
 2) use series of "Prev/Next's" for select

Figure 4-11: NEOs StorageLoader Library Service Menu

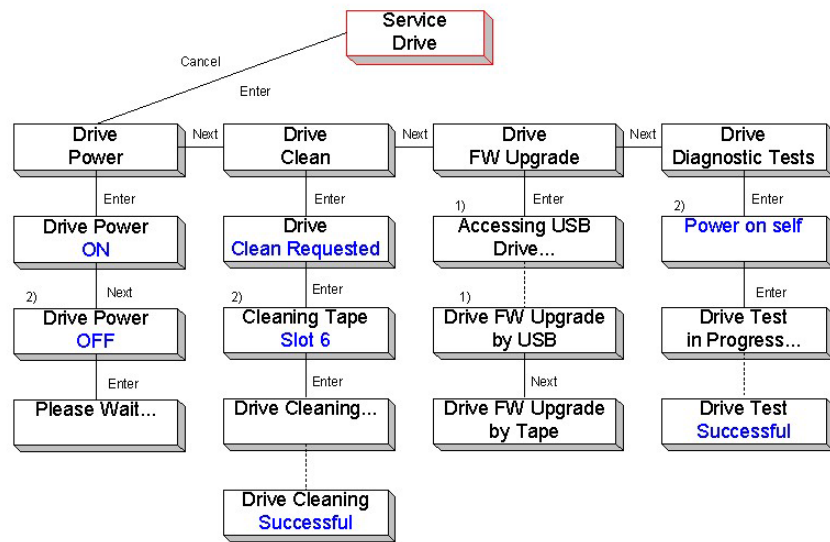

Figure 4-12: NEOs StorageLoader Drive Service Menu

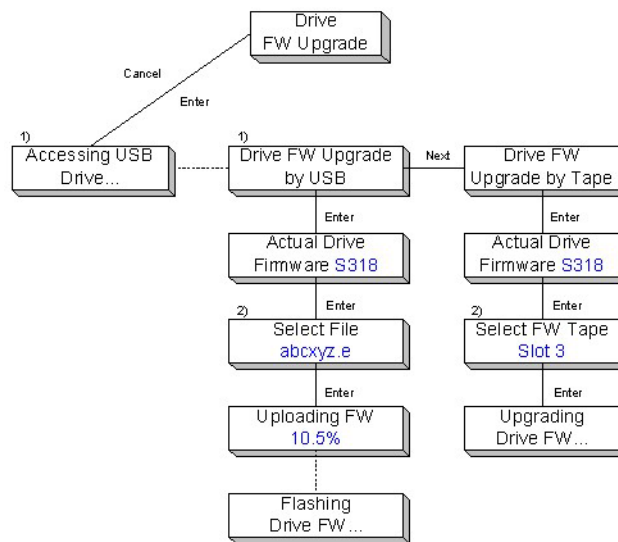

Figure 4-13: NEOs StorageLoader Firmware Upgrade Menu

NEOs T24 (2U) Tape Library Menus

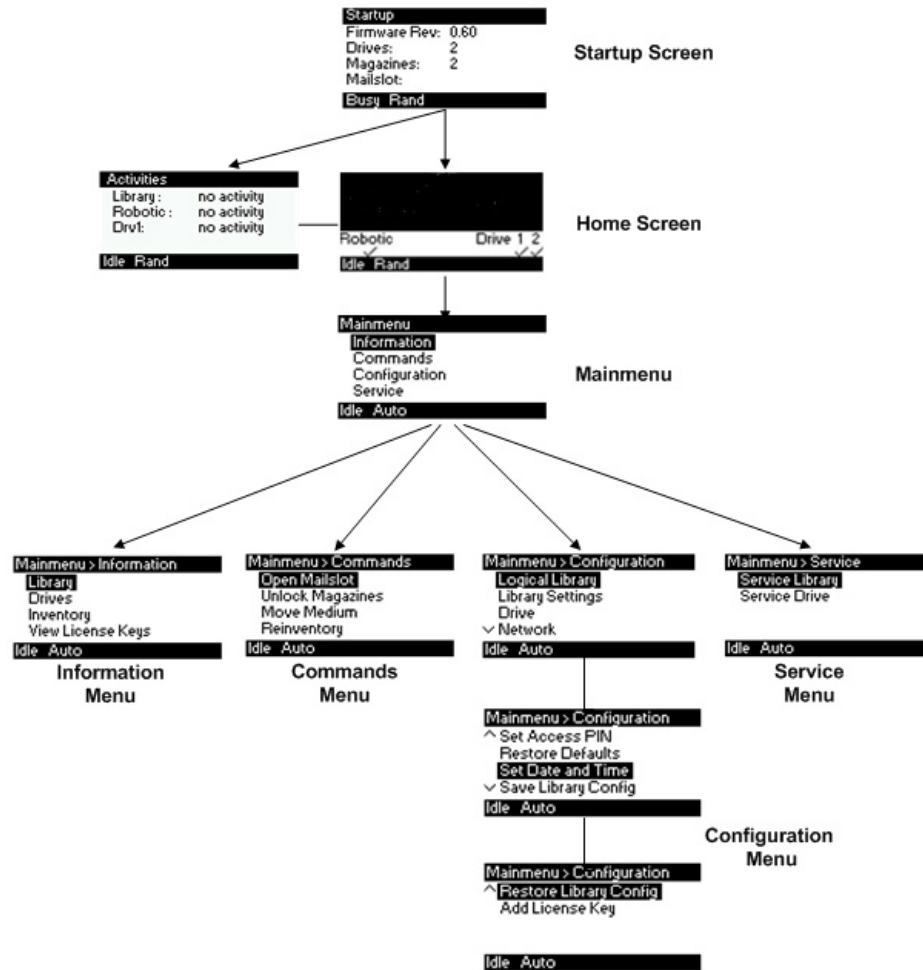

Figure 4-14: NEOs T24 Library Main Menu

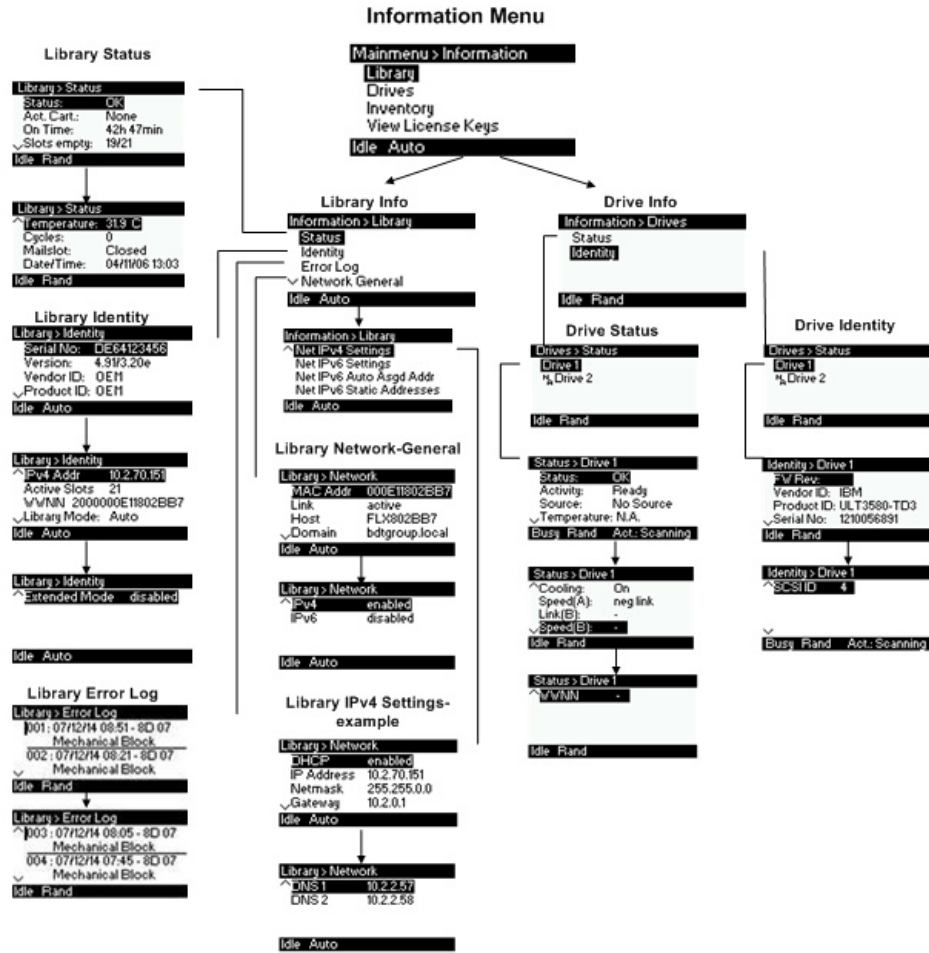

Figure 4-15: NEOs T24 Library Information Menu (Part 1)

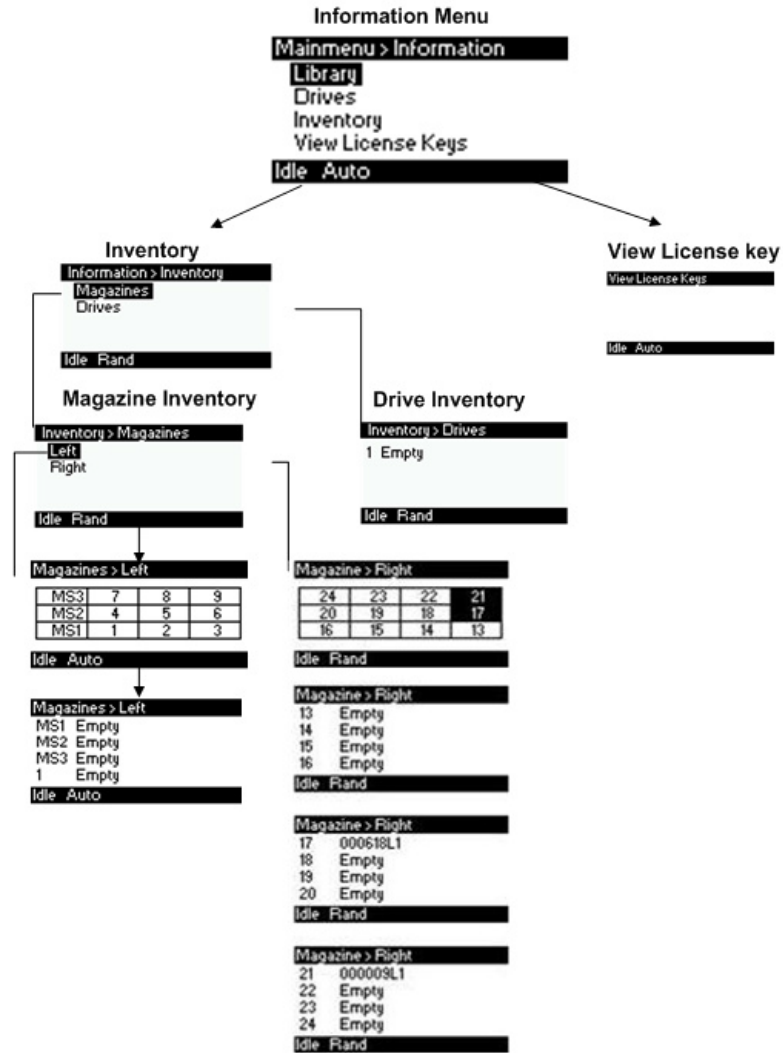

Figure 4-16: NEOs T24 Library Information Menu (Part 2)

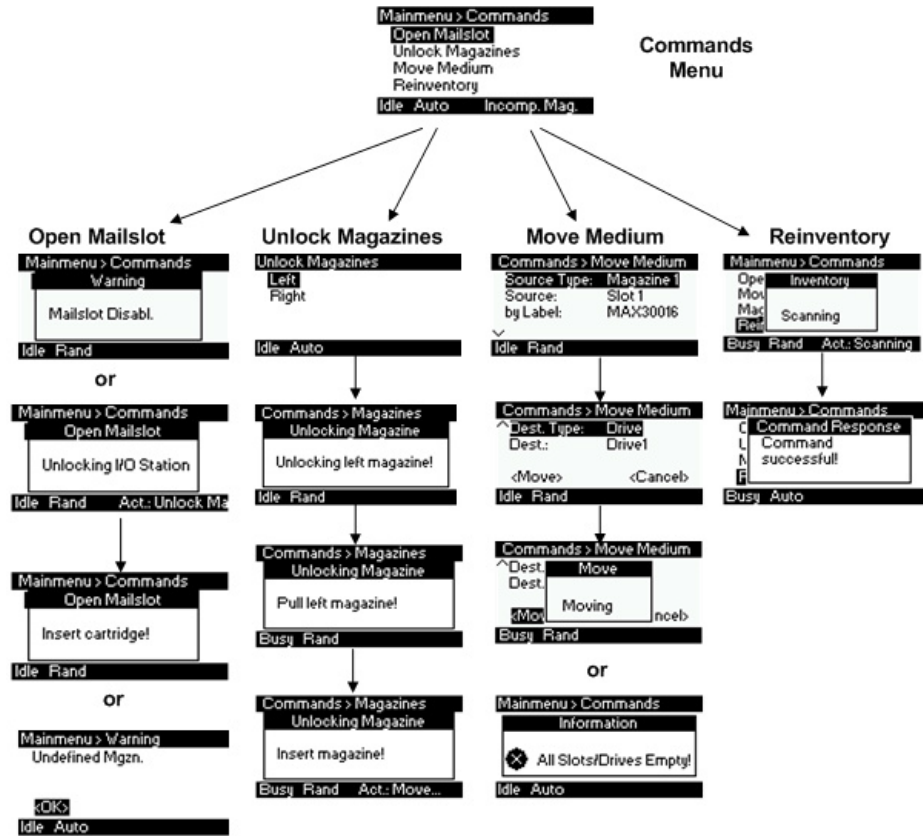

Figure 4-17: NEOs T24 Library Commands Menu

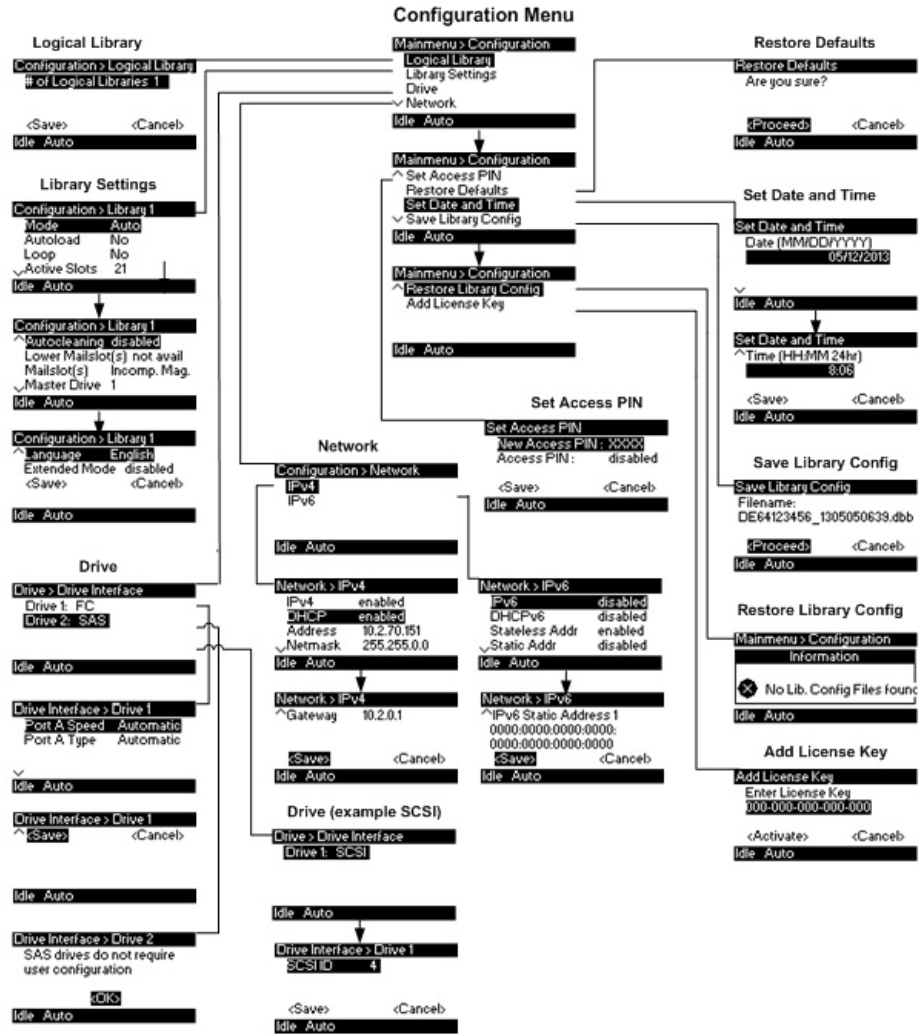

Figure 4-18: NEOs T24 Library Configuration Menu

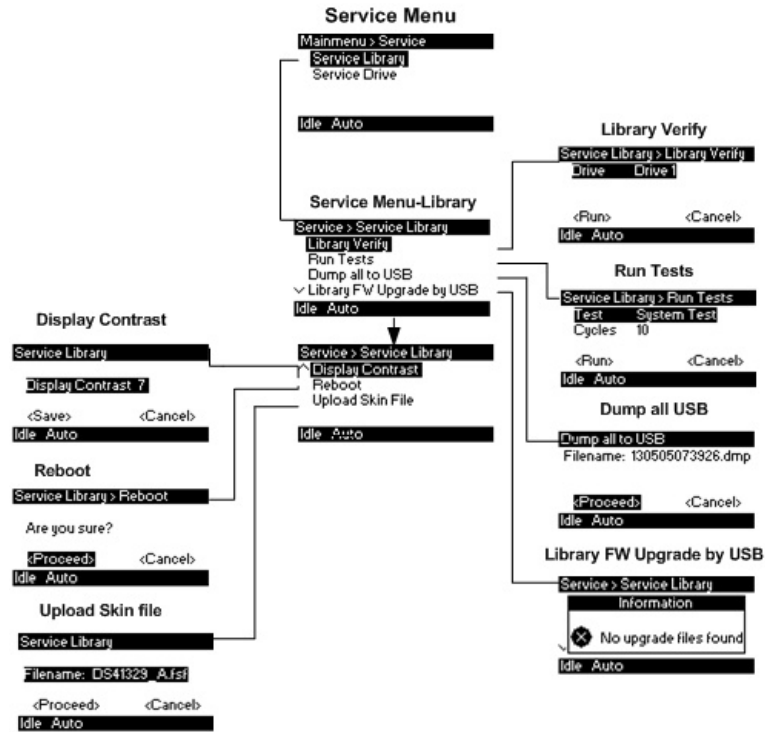

Figure 4-19: NEOs T24 Library Service Menu (Part 1)

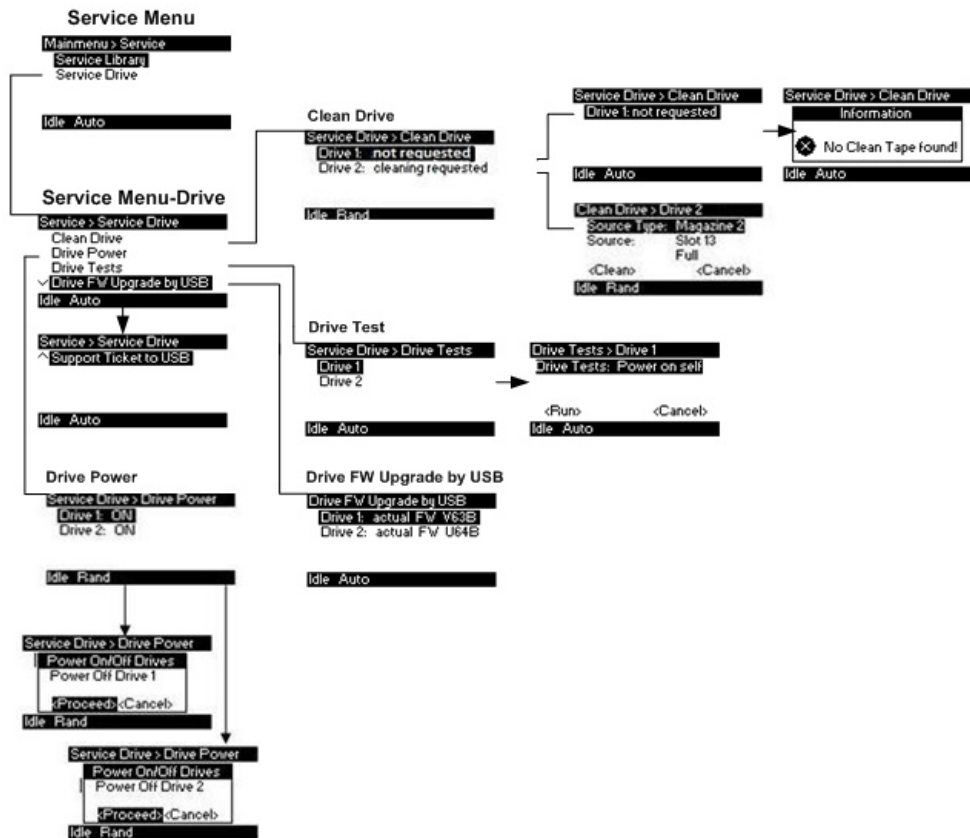

Figure 4-20: NEOs T24 Library Service Menu (Part 2)

The following table details the drive information menu:

Drive Data Item	Values	User Notes
FC drive dialog		
Firmware Revision	String	
Vendor ID	String	
Product ID	String	
Serial Number	String	
WWNN	String	
Topology A	Auto point to point arb loop	
Speed A	Auto 1 2 4 8 Gb/s	
Loop ID A	-- 0...127	
Topology B	Auto point to point arb loop	
Speed B	Auto 1 2 4 8 Gb/s	
Loop ID B	-- 0...127	
SAS drive dialog		
Firmware Revision	String	
Vendor ID	String	
Product ID	String	
Serial Number	String	
WWPID A	String	
WWPID B	String	
Firmware Revision	String	

5

Remote Management Interface

The Remote Management Interface (RMI) is a web interface for NEO S-Series Tape Library that lets you monitor and control the library from any computer connected to the internet, provides access to the online help, and is easier to use than the OCP. The RMI on the library controller hosts a dedicated, protected website that displays a graphical representation of the library.

NOTE: To access the RMI, you must first set the desired static IP address with the OCP or configure the library to use DHCP.

After establishing a connection to the library, open any HTML browser and enter the IP address of the library.

Topics in Remote Management Interface:

- [Overview](#)
- [Identity Screens](#)
- [Status Screens](#)
- [Configuration Screens](#)
- [Operations Screens](#)
- [Service Screens](#)

Overview

To view the different operations, click a menu tab at the top of the screen. That tab text changes to an italic font and displays the available operations below it. Click an operation to view the appropriate screen and its options. Click **Refresh** to update the information.

The following operations are available through the RMI:

Menu Item	Operation	Details Link
Identity	View static library information	Library (Info)
	View static drive information	Drive (Info)
	View static network information	Network (Info)
Status	View dynamic library status	Library (Status)
	View dynamic drive status	Drive (Status)
	View library cartridge inventory status	Inventory (Status)

Menu Item	Operation	Details Link
Configuration	Change the system configuration	System
	Configure logical libraries	Logical Libraries
	Enter a license key	License Key
	Change drive configurations	Drive
	Change the network configuration	Network
	Set the SNMP configuration	SNMP
	Change library user configurations	User
	Set the date and time	Date/Time
	Set the error log mode	Log
	Set the email notification parameters	Email Notification
	Restore factory default settings	Restore Defaults
Operations	Move media within the library	Move Media
	Determine current media inventory	Inventory
	Release and replace magazines	Magazines
Service	General library diagnostics	General Diagnostic
	General drive diagnostics	Drive Diagnostic
	Determine/update current firmware	Firmware
	Reboot the library	Reboot
	View the library logs	Library Logs
	Clean tape drives	Clean Drive
	View detailed information on all library cartridges	Cartridge Memory

RMI Icons

These key icons are used in the RMI:

- **OK Status** (✓) – The green check mark indicates that the library is fully operational and that no user intervention is required.
- **Warning** (!) – The yellow exclamation point indicates that user intervention is necessary but that the library is still capable of performing operations.
- **Error** (X) – The red X indicates that user intervention is required and that the library is not capable of performing operations.

Login



CAUTION: Some RMI options take the library offline. This inactive mode can interfere with the host-based application software causing data loss. Make sure the library is idle before attempting to perform any remote operations that will take the library offline.

To login, select the access level and enter the correct password. There are three levels of access:

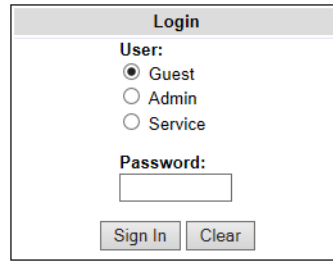

The login screen is titled "Login" and contains the following elements:

- User:** Three radio button options: "Guest" (selected), "Admin", and "Service".
- Password:** A text input field.
- Buttons:** "Sign In" and "Clear" buttons at the bottom.

Figure 5-1: RMI Login Screen

- **Guest** – Standard user level.
- **Admin** – Administrator user level.
- **Service** – Access by service personnel only.

Each level affects which areas you have access to and what actions you can initiate from those areas.

Identity Screens

Library (Info)

This screen provides access to the static information about the library. No changes can be made from this screen.

<i>Identity</i>	Status	Configuration	Operations	Service
<i>Library</i>	<i>Drive</i>	<i>Network</i>		
Library Information				
Serial Number	MX64100366			
Product ID	FlexStor II			
Currently Installed Library Firmware	5.60 / 3.20e			
Bootcode Firmware Revision	0.82			
Barcode Reader	SE625			
Library Mode	Automatic, Random			
WWide Node Name	2000000E1115C393			

Figure 5-2: RMI Identity – Library Screen

The following library information is displayed:

- **Serial Number**
- **Product ID**
- **Currently Installed Library Firmware**
- **Bootcode Firmware Revision**
- **Barcode Reader**
- **Library Mode**
- **WWide Node Name**
- **Extended Logical Library Information**

If the unit has more than one partition, the properties shown are displayed for each partition.

Drive (Info)

This screen provides access to the static information about the drives. No changes can be made from this screen.

Identity	Status	Configuration	Operations	Service
Library	Drive	Network		
Drive Information		1 (LUN)		
Vendor ID	IBM			
Product ID	ULTRIUM-HH7			
Serial Number	10WT015717			
Firmware Revision	K4K1			
World Wide ID - Port A	5000E1115C393002			
World Wide ID - Port B	5000E1115C393003			
Physical Drive Number	1			
Element Address	1			
Library Master Drive	Yes			
Data Compression	No			
Interface Type	SAS			
Drive Information		2		
Vendor ID	IBM			
Product ID	ULTRIUM-HH7			
Serial Number	10WT033929			
Firmware Revision	K4K1			
World Wide ID - Port A	5000E1115C393005			
World Wide ID - Port B	5000E1115C393006			
Physical Drive Number	2			
Element Address	2			
Library Master Drive	No			
Data Compression	No			
Interface Type	SAS			

Figure 5-3: RMI Identity – Drive Screen

The drive information is displayed for up to four full-height or eight half-height tape drives:

- **Drive Information** – LUN/drive number.
- **Vendor ID** – Manufacturer identification of the drive.
- **Product ID** – Model identification of the drive.
- **Serial Number** – Serial number of the drive.
- **Firmware Revision** – Operating firmware level of the drive.
- **World Wide ID Port / SCSI ID** – Unique unit identifier of the drive.
- **Physical Drive Number** – A number indicating the physical position within the library.
- **(SCSI) Element Address** – A number indicating the logical identification of the drive.
- **Library Master Drive** – Indicates if library interface is hosted by drive.
- **Data Compression** – Indicates if drive hardware data compression is enabled.
- **Interface Type** – Indicates drives physical interface connection style.

Network (Info)

This screen provides access to the network information about the connections of the library. No changes can be made from this screen.

<i>Identity</i>	Status	Configuration	Operations	Service
<i>Library</i>				
<i>Drive</i>				
Network				
Network Information				
MAC Address		000E1115C393		
Full Qualified Domain Name		FLX15C393.devnet.myoverland.net		
IPv4 Addressing				
IPv4 Addressing		Enabled		
IPv4 DNS Server 1		0.0.0.0		
IPv4 DNS Server 2		0.0.0.0		
DHCPv4 Addressing				
DHCPv4 Addressing		Disabled		
IPv4 Address		10.20.35.24		
Subnet Mask		255.255.0.0		
Default Gateway		10.20.8.1		
IPv6 Addressing				
IPv6 Addressing		Disabled		
SNMP				
SNMP		Disabled		
Email Notification				
Email Notification		Disabled		
Clock Synchronization Configuration (SNTP)				
Clock Synchronization Configuration (SNTP)		Disabled		

Figure 5-4: RMI Identity – Network Screen

The following information is displayed:

- **MAC Address**
- **Full Qualified Domain Name**
 - **IPv4 Addressing**
 - **IPv4 DNS Server 1**
 - **IPv4 DNS Server 2**
 - **DHCPv4 Addressing**
 - **IPv4 Address**
 - **Subnet Mask**
 - **Default Gateway**
- **IPv6 Addressing**
- **SNMP**
- **Email Notification**
 - **To Email Address**
 - **SMTP Server Address (IPv4)**
 - **Notification Level**
- **Clock Synchronization Configuration (SNTP)**

Status Screens

Library (Status)

This RMI screen displays the dynamic information about the library, such as the current status of the components.

Identity	Status	Configuration	Operations	Service
<i>Library</i>	<i>Drive</i>	<i>Inventory</i>		
Library Status At 18:49:53 Library Time				
Status	✓ Ready			
Cartridge In Transport	None			
Number Of Moves	4919			
Total Power On Time	1112d 23h 42min			
Robotic Status	Ready			
Internal Temperature	34.1 °C			
Left Magazine	Present			
Right Magazine	Present			
Refresh				

Figure 5-5: RMI Status – Library Screen

Library status is displayed:

- **Status** – Shows [RMI Icons](#) and if the library is ready to accept commands.
- **Cartridge in Transport** – Indicates if the robot has a cartridge.
- **Number Of Moves** (Odometer) – Displays total number of moves based on automated moves (ISV/Applications), manual moves (Front Panel/RMI) and general diagnostics (Slot2Slot, System Test).
- **Total Power-On Time** – Shows total library power on time since the last cycling of the power.
- **Robotic Status** – Indicates if the robot is ready to accept commands.
- **Internal Temperature** – Displays internal unit temperature in degrees centigrade (°C).
- **Presence of Magazine** – Indicates the presence of tape magazines in the library.

An RMI box to the right of the Library status table shows the system status:

System Status	
View Legend	
Updated:	10/8/2019 15:1:2
Status	✓ Ready
Drive 1 Status	✓ Ready
Drive 2 Status	✓ Ready
Slots (Free/Total)	20/23
Mailslot	Closed
Library Time	18:52:25

Figure 5-6: RMI Status – Library System Screen

- **Status** – Overall library status.
- **Drive Status** – Individual drive status (there is one entry for each installed drive).
- **Slots (Free/Total)** – Shows the free and total slots of the library.
- **Mailslot** – Indicates if an Import/Export mailslot is configured.

- **Library Time** – Displays the current time stamp in 24-hour format.
- **Auto Clean Status** – Show information regarding the cleaning of the drives. (only shown if the Auto Clean Option is enabled).

Drive (Status)

This screen provides detailed information about all drives that are present in the library. If necessary, scroll down to see all the information.

Identity	Status	Configuration	Operations	Service
Library	Drive	Inventory		
Drive 1 Status At 18:53:56 Library Time				
Status	✓ Ready			
Cartridge In Drive	None			
Drive Error Code	No Error			
Cooling Fan Active	✓			
Drive Activity	Ready			
Port A Status	Ready, connected			
Speed	6 Gb/sec			
Hashed SAS address	5A7173			
Port B Status	Not ready, not connected			
Speed	-			
Hashed SAS address	000000			
Drive 2 Status At 18:53:56 Library Time				
Status	✓ Ready			
Cartridge In Drive	None			
Drive Error Code	No Error			
Cooling Fan Active	✓			
Drive Activity	Ready			
Port A Status	Ready, connected			
Speed	6 Gb/sec			
Hashed SAS address	36ECAF			
Port B Status	Not ready, not connected			
Speed	-			
Hashed SAS address	000000			
<input type="button" value="Refresh"/>				

Figure 5-7: RMI Status – Drive Screen

Displays [RMI Icons](#) and the following information (for up to four full-height or eight half-height tape drives):

- **Status** – Displays the current status of the drive. A check mark (✓) indicates that the drive is operating properly, an exclamation point (!) indicates that the drive is operating but has a problem, and an X indicates that the drive is not operational because of a serious problem.
- **Cartridge in Drive** – Shows the serial number of the cartridge currently in the drive. If the drive does not contain a cartridge, **None** is displayed.
- **Drive Error Code** – If the drive has generated an error code, it is displayed here. If the drive has not generated an error, **No Error** is displayed.
- **Cooling Fan Active** – Displays whether the drive's cooling fan is ON (checked) or OFF.
- **Drive Activity** – Indicates whether or not the drive is operating.
- **Drive Port Status** (if present) – Indicates whether the port is logged on or out.
 - **Speed** – Shows the current speed setting of the drive. Choices are **Auto**, **6 Gb/sec**, **8 Gb/sec**, or **12 Gb/sec**. The Auto setting is where the drive automatically negotiates the speed of the drive to match that of the server.
 - **Hashed SAS Address** – The Hashed SAS address is a value which is calculated.

Inventory (Status)

This screen provides detailed information about the tape inventory in the library. A graphic summary of each magazine is shown displaying slots containing media and the magazine's position in the library.

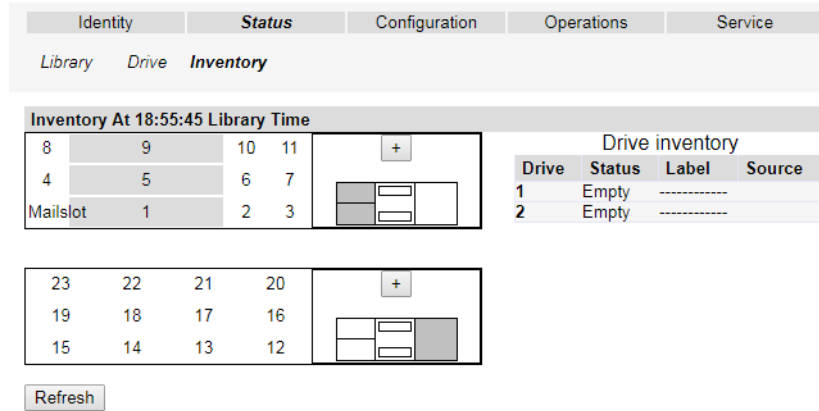

Figure 5-8: RMI Status – Library Cartridge Inventory Screen

To the right of the magazine information is a table showing the drive media inventory.

To get detailed information for a specific magazine, click the plus (+) button above the graphic showing the magazine's position. This expands the display for the specified magazine and provides detailed cartridge information. To close the Media Details, click the minus (-) button that replaced the plus (+) button.

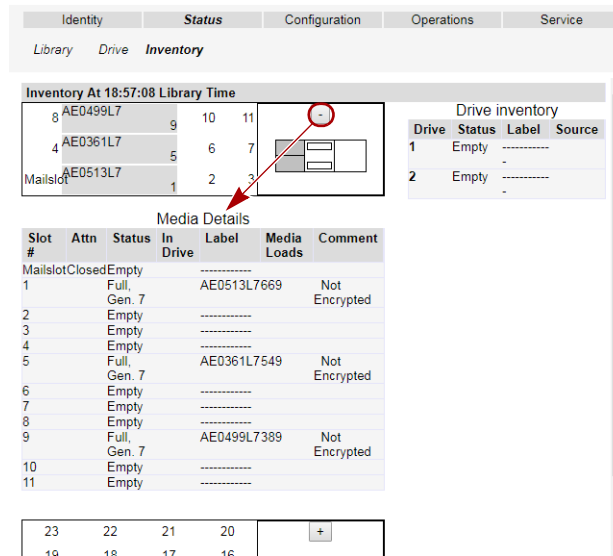

Figure 5-9: RMI Status – Library Cartridge Inventory Screen Details (Plus Button Pressed)

Configuration Screens

System

This screen allows the user to change the system configuration.

Identity	Status	Configuration	Operations	Service						
System	Logical Libraries	License Key	Drive	Network	SNMP	User	Date/Time	Log	Email Notification	Restore Defaults
System Configuration										
Library Master Drive	1 ▼									
Library Mode	<input type="radio"/> Random <input type="radio"/> Sequential <input checked="" type="radio"/> Automatic <input type="checkbox"/> Autoload <input type="checkbox"/> Loop									
Active Slots	23 ▼									
Telnet Enabled	<input type="checkbox"/>									
Mailslot Enabled	<input checked="" type="checkbox"/>									
Auto Clean Enabled	<input type="checkbox"/>									
Barcode Label Length Reported To Host	15 ▼									
Barcode Label Alignment Reported To Host	Left ▼									
Select Language	English ▼									
Enable Extended Mode	<input type="checkbox"/>									
<input type="button" value="Refresh"/> <input type="button" value="Apply"/>										

Figure 5-10: RMI Configuration – System Screen

Changes that can be made to the system configuration:

- **Library Master Drive** – The master drive number of the library LUN. Use the drop-down list to change it.
- **Library Mode** – Specifies the library mode for the library. The library supports three behavior modes: random, sequential, and automatic.
 - **Random** – In random mode, the library does not automatically load tapes into the tape drives. The random mode is used with a full-featured or robotics-aware backup application and is the most common mode of operation.
 - **Sequential** – In sequential mode, the library automatically loads and unloads tapes from the tape drive. The sequential mode is used when the backup software is not robotics-aware or was designed for standalone drives only.

In **Sequential** mode, the user can set the **Loop** and **Autoload** options. In **Loop** mode, the original first tape in the sequence is reloaded after the library has cycled through all available tapes. In the **Autoload** mode, the library automatically loads the tapes from the lowest-numbered full slot into the tape drive.

NOTE: Autoload always starts with the lowest number, in this case slot 1. So having both options enabled will cause it to start at slot 1, then loop around automatically. In Loop mode only, if you load the first tape into the drive (for example slot 12), then that slot will be the starting point of the looping.

- **Automatic** – This is the default mode. In automatic mode, the library switches from sequential mode into random mode when it receives library SCSI commands through its unique LUN ID.
- **Active Slots** – In this field, the user can select the number of slots in the library that are available to the backup software. Normally used for licensing requirements.
- **Telnet Enabled** – Only for use by factory service.
- **Mailslot Enabled** – Enabling mailslots in the library provides easier loading/unloading of media but reduces the total number of storage slots available.

- **Auto Clean Enabled** – When auto clean is enabled, the library automatically loads a cleaning cartridge when a tape drive needs to be cleaned. The library identifies a tape as a cleaning tape if it has a barcode label that starting with CLN or after an unlabeled cleaning tape has been loaded into the tape drive.
- **Barcode Label Length Reported to Host** – Default is 15. Range can be 6-15.
- **Barcode Label Alignment Reported To Host** – Default is Left. Can be set to Right.
- **Select Language** – Allows the user to specify the language displayed by the RMI. The default display language is English. Possible alternate language selections are German, Italian, Spanish, and French. For the selection to take affect, **Apply** must be clicked and the screen refreshed.
- **Enable Extended Mode** – Not used at this time.

Changes will only be applied after the **Apply** button is clicked.

After applying the changes, a warning pop-up informs the user of the impact of the proposed change. In some cases, a pop-up screen asks to confirm the change. Many changes also require a reboot.

Logical Libraries

The **Select Mode** drop-down menu allows library to be partitioned into smaller “logical libraries.” Each logical library must contain at least one tape drive.

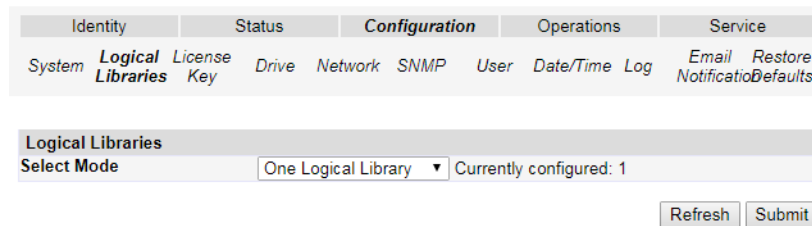

Figure 5-11: RMI Configuration – Logical Libraries Screen

License Key

NOTE: Contact your supplier to see if this functionality is applicable in your model.

This screen allows additional functionality to be added to the unit by entering a new license key in the **Add New License Key** field and clicking **Submit**. A list of current licenses is listed at the bottom.

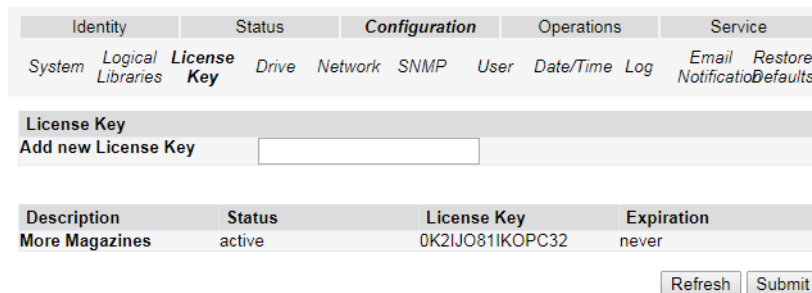

Figure 5-12: RMI Configuration – License Key Screen

Drive

This screen shows the current configuration of all the tape drives in the library and allows modification of the drive number. The user is also able to select the **Power On** option that activates the drives.

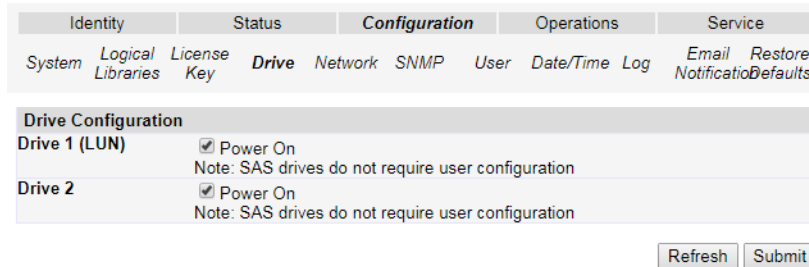

Figure 5-13: RMI Configuration – Drive Screen

Network

NOTE: Changes in this menu may affect the ability to access the RMI unless the correct IP address is resolved.

This screen shows the current network configuration of the library and allows modification of the configuration. When a change is requested, a confirmation pop-up window appears before the changes are applied.

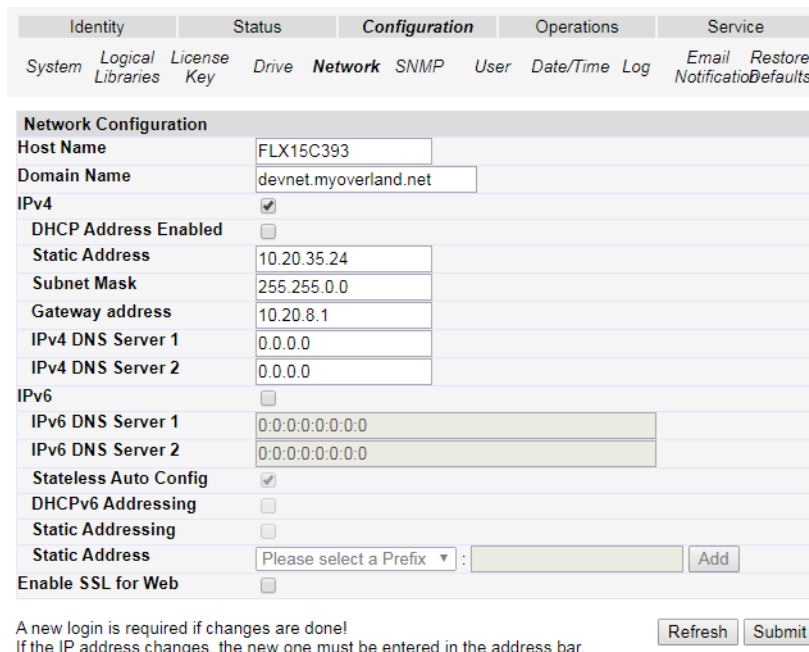

Figure 5-14: RMI Configuration – Network Screen

Changes that can be made to the network configuration:

- **Host Name** – Enter the name you wish to use to use to address this library. It is recommended that you use a name that is relevant to its location and/or its purpose.
 - The Host Name may be up to 15 characters long.
 - Allowed characters are: [A-Z], [a-z], [0-9], hyphen [-], and period [.]

- Non-allowed characters are: hyphen as the first character, blanks, or consecutive hyphens.
- **Domain Name** – This shows the domain the library is registered in and can be updated by editing the name and submitting the change.
 - The Domain Name may be up to 39 characters long.
 - Allowed characters are: [A-Z], [a-z], [0-9], hyphen [-], and period [.]
 - Non-allowed characters are: hyphens as the first or last character, blanks as the first or last character, consecutive hyphens, or consecutive periods. If consecutive periods are entered in error, a message about a domain name not valid is shown.
- **IPv4** – Check the box to use this protocol and options:
 - **DHCP Address Enabled** – Used to have the RMI seek an assigned IP address from the network's DHCP server.
 - **Static Address** – This field is only active with DHCP address off (unchecked). A static IP address can be entered in this field.
 - **Subnet Mask** – Used to set the Network Mask—if required, contact your Network administrator to get this address.
 - **Gateway Address** – Used to set the Gateway Address—if required, contact your Network administrator to get this address. (It is used when an IP address does not match any other routes in the routing table).
 - **IPv4 DNS Server 1** – This is the IPv4 address of your primary name server (DNS server).
 - **IPv4 DNS Server 2** – This is the IPv4 address of your alternate name server (DNS server).
- **IPv6** – Check the box to use this protocol and options:
 - **IPv6 DNS Server 1** – This is the IPv6 address of your primary name server (DNS server).
 - **IPv6 DNS Server 2** – This is the IPv6 address of your alternate name server (DNS server).
 - **Stateless Auto Config** – When enabled, the device generates an address for itself based on the routing information obtained from a router advertisement and the MAC address. The device can manage up to five global addresses at the same time, which can be assigned from different routers.
 - **DHCPv6 Addressing** – Used to enable DHCP addressing assignment from network name server.
 - **Static Addressing** – Used to enable a static IP address for the RMI access.
 - **Static Address** – Sets the static IP address for the RMI access.
- **Enable SSL for Web** – When SSL is enabled, connections to the RMI must use HTTPS.

SNMP



IMPORTANT: If the IP address changes, then the IPv4 address or Host name and domain will have to be updated.

If a host and a domain name are entered instead of an address, the IPv4 or IPv6 IP address will be resolved from the DNS using that name. That IP address is stored in the library rather than the domain name.

Identity		Status		Configuration		Operations		Service	
System	Logical Libraries	License Key	Drive	Network	SNMP	User	Date/Time Log	Email Notification	Restore Defaults
SNMP Configuration									
SNMP Enabled <input type="checkbox"/>									
IPv4 SNMP Target Addresses									
IPv4 Target 1		0.0.0.0		Version		SNMPv1		IPv4	
address or Host name and domain *									
IPv4 Target 2		0.0.0.0		Version		SNMPv1		IPv4	
address or Host name and domain *									
IPv4 Target 3		0.0.0.0		Version		SNMPv1		IPv4	
address or Host name and domain *									
IPv6 SNMP Target Addresses									
IPv6 Target 1		0:0:0:0:0:0:0:0		Version		SNMPv1		IPv6	
address or Host name and domain *									
IPv6 Target 2		0:0:0:0:0:0:0:0		Version		SNMPv1		IPv6	
address or Host name and domain *									
IPv6 Target 3		0:0:0:0:0:0:0:0		Version		SNMPv1		IPv6	
address or Host name and domain *									
Community Name		public							
Security User Name		initial							
SNMP Trap Notification Filter		<input type="radio"/> Critical Events <input type="radio"/> Critical and Warning Events <input type="radio"/> Critical, Warning and Configuration Events <input checked="" type="radio"/> Critical, Warning, Configuration and Informational Events <input type="radio"/> No Events							

* If a host and domain name are entered instead of an address, the IPv4 or IPv6 address will be resolved from the DNS using that name. That address will be stored in the library rather than the name.

Figure 5-15: RMI Configuration – SNMP Screen

Changes that can be made to the SNMP configuration:

- **SNMP Enabled** – Check this box to have SNMP traps sent to a SNMP Management consoles.
- **IPv4 SNMP Target Addresses** – Enter up to three IPv4 addresses in the fields that follow and select the version from the drop-down menus:
 - **IPv4 Target 1** – If SNMP traps are enabled, enter an IP address where SNMP traps are to be sent.
 - **IPv4 Target 2** – Enter an optional second IP address where SNMP traps are to be sent, or leave as 0.0.0.0.
 - **IPv4 Target 3** – Enter an optional third IP address where SNMP traps are to be sent, or leave as 0.0.0.0.
 - **Version** – The library offers three versions of the SNMP protocol; v1, v2 and v3. Select a version for each Target IP Address.
- **IPv6 SNMP Target Addresses** – Enter up to three IPv6 addresses in the fields that follow and select the version from the drop-down menus:
 - **IPv6 Target 1** – If SNMP traps are enabled, enter an IP address where SNMP traps are to be sent.
 - **IPv6 Target 2** – Enter an optional second IP address where SNMP traps are to be sent, or leave as 0:0:0:0:0:0:0:0.
 - **IPv6 Target 3** – Enter an optional third IP address where SNMP traps are to be sent, or leave as 0:0:0:0:0:0:0:0.

- **Version** – The library offers three versions of the SNMP protocol; v1, v2 and v3. Select a version for each Target IP Address.
- **Community Name** – An SNMP community name is a text string that acts as a password to authenticate messages sent between the SNMP remote management application and the library. Enter your preferred name, or leave as the default **public**.
- **Security User Name** – Whatever the user name is used for the SNMP Management System. Unique to whatever is used as an SNMP Manager.
- **SNMP Trap Notification Filter** – Select one of the following alert combinations about which to receive notifications:
 - **Critical Events**
 - **Critical and Warning Events**
 - **Critical, Warning, and Configuration Events**
 - **Critical, Warning, Configuration, and Information Events**
 - **No Events**

User

This screen allows the user to modify the user accounts for the three different access levels: Guest, Admin, or Service.

Identity		Status	Configuration			Operations	Service	
System	Logical Libraries	License Key	Drive	Network	SNMP	User	Date/Time Log	Email Restore Notification Defaults
User Configuration								
Access Level					2 ▼			
Access Level Name					admin			
New Password (Enter Up To Ten Characters)							
Repeat Password							
OCP Access Pin Enabled					<input type="checkbox"/>			
OCP Access Pin Code							
Repeat OCP Access Pin Code							
Support Name								
Support Phone								
Support Email								
						Refresh	Submit	

Figure 5-16: RMI Configuration – User Screen

Changes that can be made to the user configuration:

- **Access Level** – Choose from **1** (Guest), **2** (Admin), or **3** (Service).
- **Access Level Name** – The name associated with the chosen access level (non-editable).
- **New Password (Enter Up To Ten Characters)** – The user password can be a maximum of ten characters.
- **Repeat Password** – Enter the user password again to confirm.
- **OCP Access PIN Enabled** – Select this item to enable password protection for the OCP.
- **OCP Access PIN Code** – If the OCP Access PIN is enabled, enter a PIN (password) for it (4 character maximum).
- **Repeat OCP Access PIN Code** – Enter the OCP Access PIN again to confirm.
- **Support Name** – Enter the name of the individual within your company to contact for RMI or library support (30 character maximum).

- **Support Phone** – Enter the phone number of the individual within your company to contact for RMI or library support (30 character maximum).
- **Support Email** – Enter the email address of the individual within your company to contact for RMI or library support (30 character maximum).

Date/Time

This screen allows the user to set the date and time, and how it is displayed.

Identity		Status		Configuration			Operations	Service	
System	Logical Libraries	License Key	Drive	Network	SNMP	User	Date/Time	Log	Email Notification Defaults

Clock Configuration

Time (24H) : :

Date Month : Day : Year :

Clock Synchronization Configuration (SNTP)

Enable Clock

Synchronization

SNTP Server Address (IPv4) IPv4 address or Host name and domain

UTC Time

Zone Offset

Daylight Saving Enabled

* If a host and domain name are entered instead of an address, the IPv4 or IPv6 address will be resolved from the DNS using that name. That address will be stored in the library rather than the name. Therefore, if the address changes, then the name or a new address will have to be entered.

Figure 5-17: RMI Configuration – Date/Time Screen

Changes that can be made to the date and time configuration:

- **Clock Configuration** – Use the following two options to set the time and date of the internal clock:
 - **Time (24H)** – Set the 24-hour format using a **HH:MM:SS** format.
 - **Date** – Set the date using a **MM:DD:YYYY** format.
- **Clock Synchronization Configuration (SNTP)** – Use these options for using Network Time Protocol (NTP) for time management:
 - **Enable Clock Synchronization** – Check the box to use NTP synchronization and activate the other NTP options.
 - **SNTP Server Address (IPv4)** – This is the IPv4 address or Host name and domain of the network SNTP time server (40 character maximum).
 - **UTC Time Zone Offset** – Use this drop-down menu to select the appropriate time zone offset so the library time is displayed in the local time.
 - **Daylight Saving Enabled** – Provides for automatic offset of daylight savings time.

Log

NOTE: Only Service personnel can access the error log configuration.

This screen is used to set behavior of the error log collection. Service personal may ask to alter settings in this field during the diagnostic process. The default setting is for continuous collection of logs with the most recent events overwriting the oldest events (circular buffer).

Identity		Status		Configuration			Operations		Service	
System	Logical Libraries	License Key	Drive	Network	SNMP	User	Date/Time	Log	Email Notification	Restore Defaults
Log Configuration										
Error Log Mode				<input type="radio"/> Off <input checked="" type="radio"/> Continuous <input type="radio"/> Stop Trace At First Error						
Trace Level				<input checked="" type="checkbox"/> Cmd <input checked="" type="checkbox"/> Response <input checked="" type="checkbox"/> Event <input checked="" type="checkbox"/> Trace Data <input checked="" type="checkbox"/> Low Level Trace <input checked="" type="checkbox"/> Recovered Error <input checked="" type="checkbox"/> Hard Error						
Trace Filter				<input checked="" type="checkbox"/> Main <input checked="" type="checkbox"/> Drive <input checked="" type="checkbox"/> CDB Interpreter <input checked="" type="checkbox"/> Robotic <input checked="" type="checkbox"/> Trace <input checked="" type="checkbox"/> OCP Input <input checked="" type="checkbox"/> OCP Output <input checked="" type="checkbox"/> SCSI Module <input checked="" type="checkbox"/> SDCI Module						
<input type="button" value="Refresh"/> <input type="button" value="Submit"/>										

Figure 5-18: RMI Configuration – Error Log Screen

Changes that can be made to the error log configuration:

- **Error Log Mode** – Select either **Off**, **Continuous**, or **Stop Trace At First Error**.
- **Trace Level** – Check the items wanted.
- **Trace Filter** – Check the items wanted.

Email Notification

This screen allows the user to modify the event email notification parameters.

Identity		Status		Configuration			Operations		Service	
System	Logical Libraries	License Key	Drive	Network	SNMP	User	Date/Time	Log	Email Notification	Restore Defaults
Event Notification Configuration										
Notification Level				<input type="radio"/> Critical Events <input type="radio"/> Critical and Warning Events <input type="radio"/> Critical, Warning and Configuration Events <input checked="" type="radio"/> No Events						
To Email Address				<input type="text"/>						
SMTP Server Address (IPv4)				<input type="text" value="0.0.0.0"/>			IPv4 address or Host name and domain *			
<small>* If a host and domain name are entered instead of an address, the IPv4 or IPv6 address will be resolved from the DNS using that name. That address will be stored in the library rather than the name. Therefore, if the address changes, then the name or a new address will have to be entered.</small>										
<input type="button" value="Refresh"/> <input type="button" value="Submit"/>										

Figure 5-19: RMI Configuration – Email Notification Screen

Changes that can be made to the email notification configuration:

- **Notification Level** – Select one of the following:
 - **Critical Events**
 - **Critical and Warning Events**

- **Critical, Warning, and Configuration Events**
- **No Events**
- **To Email Address** – Enter the email address of the individual within your company to contact for RMI or library support (30 character maximum).
- **SMTP Server Address** – Enter either an IPv4 address or Host name and domain.

 **IMPORTANT:** If the IP address changes, then the IPv4 address or Host name and domain will have to be updated.

Restore Defaults

This screen allows the user to reset the configuration to the factory defaults, restore vital product data, and save vital product data.

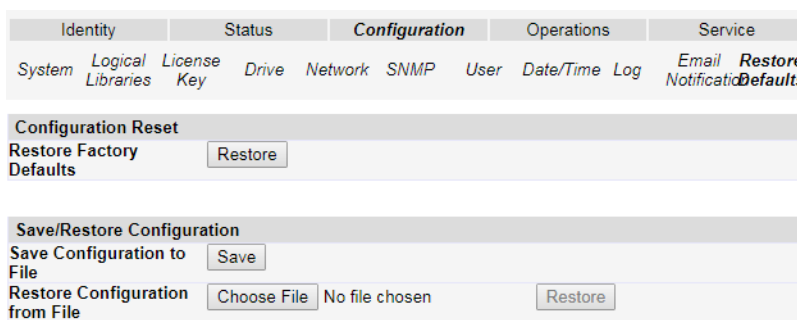

Figure 5-20: RMI Configuration – Restore Defaults Screen

Selections that can be made regarding the factory defaults:

- **Restore factory defaults** – Click this button to restore all factory default settings. Note that OEM library applications may require operational settings which differ from the factory default settings. Consult your system vendor to verify proper operational settings of the library after a restore to factory defaults.
- **Save Configuration to File** – Click this button to save the current library settings to a file which can later be uploaded back to the library to restore the settings. Library configuration files have a DBB file extension with a file name format structure consisting of the unique 10-character library unit serial number followed by a space, followed by a date time stamp formatted “YYMMDDTTTT” (YY= last two digits of current year, MM = month number, DD = date, TTTT= Hour/minute time stamp in a 24-hour time format).
- **Restore Configuration from File** – The restore option allows the administrator to restore the settings previously saved. Use the **Browse** button to select a path to a previously generated configuration DBB file. Once the correct file is located, the **Restore** button is used to upload the file back to the library.

Operations Screens

Move Media

This screen allows the user to move tape cartridges within the library.

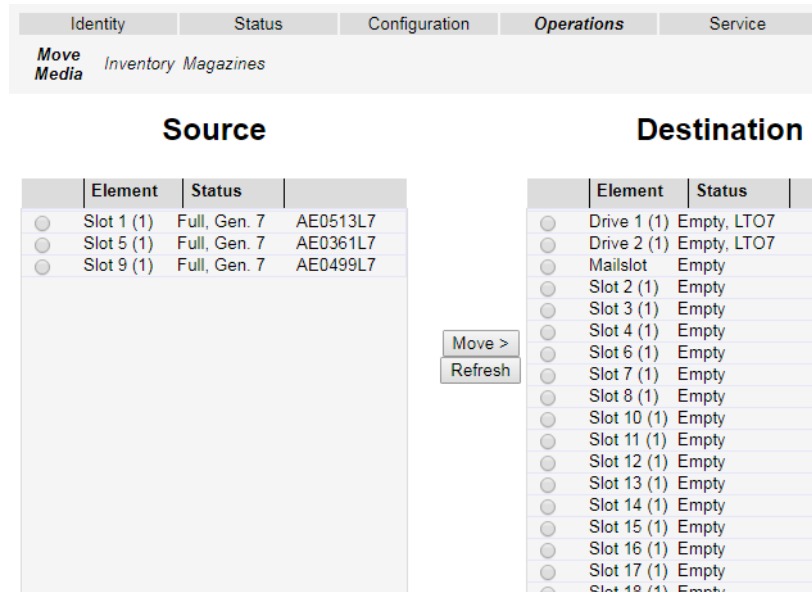

Figure 5-21: RMI Operations – Move Media Screen

Select the source and destination, then click **Move** to move a tape cartridge.

Inventory

Click **Rescan** to scan the library to determine the current media inventory.

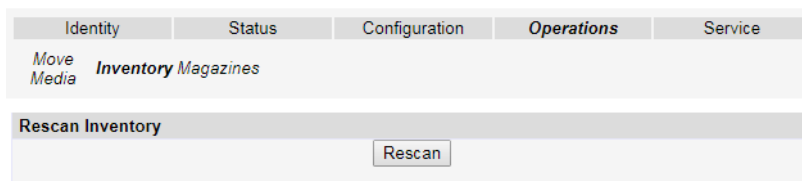

Figure 5-22: RMI Operations – Inventory Screen

Magazines

NOTE: To release a magazine manually, see [Manual Magazine Release](#). The manual process should only be used if the magazine cannot be released using the OCP or the RMI.

Use this screen to release magazines from the library. All magazines are released for the side selected.

Figure 5-23: RMI Operations – Magazines Screen

Using the drop-down menu, select either **Left** or **Right**. Click **Release** to unlock all the magazines on that side.

Service Screens

General Diagnostic

This screen provides the system administrator with general tests to verify the usability and reliability of the library. The tests include:

- **System Test** – The System test exercises library components by moving cartridges from slots to drives and back to slots. No data is written or read from the cartridges. To run this test successfully, the library must contain at least one data cartridge for every drive present in the library.
- **Slot to Slot Test** – The Slot To Slot test moves every cartridge from one slot to another, for each test cycle requested. When completing the Slot To Slot test, you need to re-inventory your library before placing it back online, since this test scrambles the cartridge slot locations.

Figure 5-24: RMI Service – General Diagnostic Screen

1. Use the drop-down menu to select either **System Test** or **Slot-to-Slot Test**.
2. Use the **No. Cycles** drop-down menu to select the number of cycles wanted.
3. Click **Execute** to test.

You can click **Stop** at any time to cancel a test.

Drive Diagnostic

This screen provides the **Admin** or **Service** user with general tests to verify the usability and reliability of the drives.

Identity	Status	Configuration	Operations	Service
<i>General</i>	<i>Drive</i>	<i>Firmware</i>	<i>Reboot</i>	<i>Library</i>
<i>Diagnostic</i>	<i>Diagnostic</i>	<i>Logs</i>	<i>Clean Drive</i>	<i>Cartridge Memory</i>

Advance Diagnostic	
Select Drive	1 ▼
Select Drive Test	Drive Self Diagnostic ▼
<input type="button" value="Execute"/>	

Drive Support Ticket	
Select Drive	Not supported for any available drive!

Save Drive Dump	
Select Drive	1 ▼
<input type="button" value="Save Drive Dump"/>	

Figure 5-25: RMI Service – Drive Diagnostic Screen

Selections that can be made:

- **Advance Diagnostic** – Select a drive number and test type, then click **Execute** to run that test on the drive.
- **Drive Support Ticket** – Select drive number and choose either **From Last Unload** or **Current (Unload)**. Click **Download** to create a support ticker.
- **Save Drive Dump** – Select a drive that supports a drive dump and click **Save Drive Dump** to save the information.

Firmware

NOTE: After a firmware upgrade, the system restarts automatically.

This screen displays the current library firmware version and drive firmware versions for all drives. Firmware can be downloaded to the host then uploaded to the library or drive in the library by using this screen.

Identity	Status	Configuration	Operations	Service
<i>General</i>	<i>Drive</i>	<i>Firmware</i>	<i>Reboot</i>	<i>Library</i>
<i>Diagnostic</i>	<i>Diagnostic</i>	<i>Logs</i>	<i>Clean Drive</i>	<i>Cartridge Memory</i>

Upgrade Library Firmware	
Currently Installed Library Firmware	5.60
Library Firmware File	<input type="button" value="Choose File"/> No file chosen <input type="button" value="Update"/>

Upgrade Drive 1 Firmware	
Drive Firmware Revision	K4K1
Drive Firmware File	<input type="button" value="Choose File"/> No file chosen <input type="button" value="Update"/>

Upgrade Drive 2 Firmware	
Drive Firmware Revision	K4K1
Drive Firmware File	<input type="button" value="Choose File"/> No file chosen <input type="button" value="Update"/>

Figure 5-26: RMI Service – Firmware Screen

Click a drive's **Browse** button to select a firmware update and then click the corresponding **Update** button to load it.

Reboot

CAUTION: Ensure that the library is idle before attempting to perform this RMI operation which takes the library offline. This inactive mode can interfere with the host-based application software causing data loss.

NOTE: During a reboot, the connection to the library may be lost. If the connection is lost, the user will have to reload the screen manually.

This screen is used to perform a library reboot. There is a default time delay as the RMI refreshes itself. This time should be sufficient to reload the screen automatically.

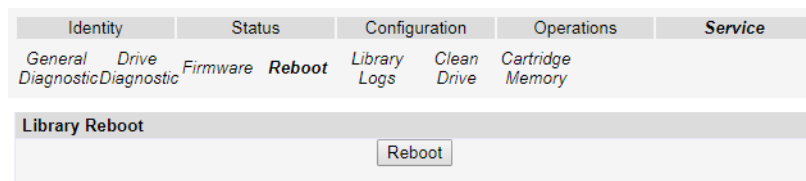

Figure 5-27: RMI Service – Reboot Screen

Library Logs

This screen allows the user to view the library logs.

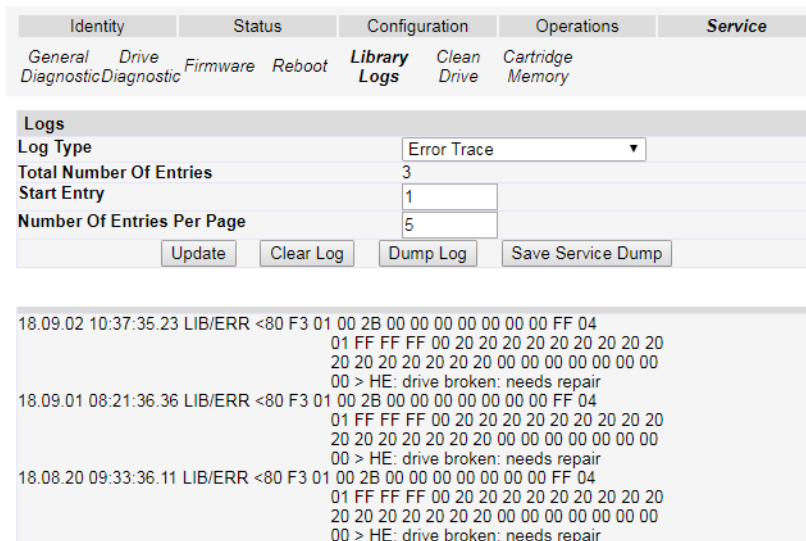

Figure 5-28: RMI Service – Library Logs Screen

Select the appropriate library logs:

- **Log Type**
 - **Error Trace** – Logs all the error messages.
 - **Informational Trace** – Logs all the informational messages created as the library operates.

- **Warning Trace** – Logs all warning messages created by the library. Warning messages does not stop a library's operation but does remind the user of issues that may become a problem. For example, **Invalid Media**.
- **Configuration Change Trace** – Logs any configuration changes made, such as changing/adding partitions, changing SCSI addresses, removing a DCS, etc.
- **Standard Trace** – Logs all library operations.
- **Total Number Of Entries**
- **Start Entry**
- **Number Of Entries Per Page**

Changes are applied only after the **Update** button is selected. **Clear Log** erases the log, **Dump Log** creates the log, and **Save Service Dump** allows the direct viewing or saving of the file.

Clean Drive

This screen allows the user to manually clean the tape drive.

Identity	Status	Configuration	Operations	Service
<i>General</i>	<i>Drive</i>	<i>Firmware</i>	<i>Reboot</i>	<i>Library</i>
<i>Diagnostic</i>	<i>Diagnostic</i>	<i>Logs</i>	<i>Clean Drive</i>	<i>Cartridge Memory</i>

Clean Drive	
Slot #	N.A.
Drive	1 - No Cleaning Required ▼
<input type="button" value="Clean"/>	

Figure 5-29: RMI Service – Clean Drive Screen

Using the drop-down menus, select the magazine slot number, select the tape drive, and then click **Clean**.



CAUTION: To prevent excessive wear on the drive heads, clean the tape drive only when the Clean Drive LED is illuminated. Use only Ultrium Universal cleaning cartridges.

Cartridge Memory

This screen provides details of the up to 96 tapes stored in the library.

Identity		Status		Configuration		Operations		Service	
<i>General</i>		<i>Drive</i>		<i>Firmware</i>		<i>Reboot</i>		<i>Library</i>	
<i>Diagnostic</i>		<i>Diagnostic</i>		<i>Logs</i>		<i>Clean</i>		<i>Cartridge</i>	
						<i>Drive</i>		<i>Memory</i>	
Cartridge Memory									
Slot	Elem ID	Vol Name	Loads	Cart Man	Cart S/N	Last Drv Vendor	Last Drv S/N	MB WR	MB RD
Mailslot 1	0 - 101	Empty							
1	0 - 1001	AE0513L7 669	HPE	5160226090	IBM	10WT015717	65198780	1151043	
2	0 - 1002	Empty							
3	0 - 1003	Empty							
4	0 - 1004	Empty							
5	0 - 1005	AE0361L7 549	HPE	4160312209	IBM	10WT033929	283720219	2481501	
6	0 - 1006	Empty							
7	0 - 1007	Empty							
8	0 - 1008	Empty							
9	0 - 1009	AE0499L7 389	HPE	2160226133	IBM	10WT015717	89233146	2804661	
10	0 - 1010	Empty							
11	0 - 1011	Empty							
12	0 - 1012	Empty							
13	0 - 1013	Empty							
14	0 - 1014	Empty							
15	0 - 1015	Empty							
16	0 - 1016	Empty							
17	0 - 1017	Empty							
18	0 - 1018	Empty							
19	0 - 1019	Empty							
20	0 - 1020	Empty							

Figure 5-30: RMI Service – Cartridge Memory Screen

- **Slot** – Magazine slot where the cartridge is currently located.
- **Elem ID** – Element ID used by the library.
- **Vol Name** – Volume name that this cartridge is connected with.
- **Loads** – Number of times the cartridge has been loaded in a drive.
- **Cart Man** – Manufacture of the cartridge.
- **Cart S/N** – Cartridge unique serial number.
- **Last Drv Vendor** – The vendor of the last drive the cartridge was loaded into.
- **Last Drv S/N** – Unique serial number of the last drive used.
- **MB WR** – Total megabytes written to the cartridge.
- **MB RD** – Total megabytes read from the cartridge.
- **TAF** – TapeAlert Flag code last stored on this cartridge.

6

Partitioning the Library

If there are two (2) drives present in a T24 library, it is possible to create two (2) logical libraries (partitions). The logical libraries resource allocation is magazine related; this means the number of available slots correlates to the magazine borders (12 slots per magazine).

When two half-height drives are installed in a T24 2U library and it is partitioned, the first partition will contain the first magazine and the first drive and the second partition will contain the second magazine and the second drive. The mailslot (if configured as I/O) is shared between the logical libraries.

Topics in Partitioning the Library:

- [Drive Naming](#)
- [Mixing of Drives](#)

Drive Naming

The position of the half-height drives determines the names used in partitioning:

- **Drive 1** – The half-height drive in the bottom drive bay.
- **Drive 2** – The half-height drive in the top drive bay.

Mixing of Drives

The T24 library supports a mix of drives from different LTO generations in the same physical library and the same logical library. They also support a mix of SAS and FC interfaces in the same physical library and the same logical library.

Single-Partition Configuration

A single-partition configuration contains any drives present in any drive bay and both magazines.



Figure 6-1: Single-Partition Configuration (Drives and Correlated Magazines)

Two-Partition Configuration

The T24 library must have two HH drives installed. Partition 1 (yellow) contains the drive in drive bay 1. Partition 1 also contains magazine 1. Partition 2 (green) contains the drive in drive bay 2. Partition 2 also contains magazine 2.



Figure 6-2: Two-Partition Configuration (Drives and Correlated Magazines)

SCSI Element Addressing

General Addressing Scheme

Every logical library starts at the first drive bay with the current assigned element start address (default value 256). It will be incremented from bottom to the top drive bay.

NOTE: The addresses used in the samples are the default addresses which are valid after manufacturing or after a “Reset to Default”. The described behavior and algorithms are also valid for different SCSI base addresses which can be changed by SCSI SMC command.

A T24 library with only one FH drive (one logical library):

SCSI Element	Drive Bay
1	2
	1

A T24 library with two HH drives (one logical library):

SCSI Element	Drive Bay
2	2
1	1

Element Address Reporting

The SCSI specification does not allow gaps in the SCSI element addressing. There is a special handling needed for drive bays which are empty to fulfill the specification. Also drives which are temporarily removed needs to be handled correctly to not confuse the attached host and host application.

General Reporting

Generally, only drives are reported which are currently physically available or “temporarily” removed. Empty slots, which are located at an edge, are not reported, with an exception in case of a “removed” condition.

A T24 library with one HH drive:

SCSI Element	Drive Bay
1	1

Removed Drives

Removed drives report a SCSI element, which is not accessible until one of the following conditions occurs:

- A drive is inserted again in the drive bay.
After this happens, the SCSI element is reported again as accessible.
- A “Reset to Default” from any UI occurs.
- The logical library configuration changes (adding / removing of libraries).

After these conditions occur, the slots are handled as empty slots and all data of removed drives is cleared.

7

Troubleshooting



IMPORTANT: Documentation of customer replaceable units (spares) is available from the Overland Expert Knowledge Base System (<http://support.overlandstorage.com/kb>).

The customer is responsible for the setup and maintenance of the library. When an error occurs during operation of the library, the library stops the current operation and displays an error code on the Operator Control Panel. Unless otherwise noted, first try to resolve the problem by cycling power to the library and retrying the last operation.

NOTE: When power cycling the library, wait 10 seconds after the power is switched OFF before powering ON again.

If the error persists, observe the LEDs on the front panel and error messages on the Operator Control Panel to determine exactly which part is failing. See [Interpreting Front Panel LEDs on page 87](#) for more information. If the LEDs on all components are functioning properly, see [Diagnosing a Problem on page 81](#).

Before placing a service call or informing the Overland-Tandberg Technical Support, use this chapter to find the reason which closest resembles the problem you are experiencing and perform the listed action regarding that problem.

If you are unable to correct the problem, create a prioritized list of replacement parts required. Select only one CRU at a time starting with the most-likely CRU based on [Isolating Problems on page 84](#) or the error code listing.

The library consists of the following Customer Replaceable Units (CRUs):

- Control Card (electronics, processor, memory, etc.)
- Power Supply
- Drive Sled (drive plus drive-to-library connectivity)
- Library Enclosure (accessor, Operator Control Panel display, etc.)
- Cartridge Magazines

Other non-library replaceable parts are:

- Data Cartridges
- Power Cable
- Network Cable
- Host Fibre/SAS Cables
- Host Bus Adapter (HBA)

After exhausting all troubleshooting efforts, contact Overland-Tandberg Technical Support.

Warranty replacement of a registered NEO S-Series Tape Library, if required, is provided by exchanging the old unit with a new unit (everything except the power cord and rack kit). The customer will be charged for on-site service if a service contract is not in place.

After correcting the problem, run **Service > Library Verify** from the Operator Control Panel to ensure that all library components are functioning properly before resuming normal library operations.

Topics in **Troubleshooting**:

- [How the Library Reports Problems](#)
- [Library Error Message Content](#)
- [Diagnosing a Problem](#)
- [Isolating Problems](#)
- [Installation and Configuration Problems](#)
- [Interpreting Front Panel LEDs](#)
- [Reseating Cables](#)
- [Emailing Logs](#)
- [Unlocking the Cartridge Magazine Manually](#)
- [Verify the Library](#)

How the Library Reports Problems

The library uses advanced problem detection, reporting, and notification technology to alert customers of problems as soon as they occur. It performs numerous self-tests to monitor the library's temperature, voltage and currents, and standard library operations. These tests monitor the library when the library is powered ON, and during normal operation when the library is idle.

If the test detects a problem, the library generates a message that identifies which component is likely causing the problem. The library's Error LED and Attention LED may turn ON to indicate an abnormal state. If the problem is not severe, the Attention LED turns ON and the library continues to provide full functionality to the library. If the problem is not recoverable, the Error LED turns ON and an error message is displayed on the Operator Control Panel.

When the library generates an attention event or an error event, support staff can be notified immediately by setting up e-mail event notification and/or SNMP trap notification. The type of event that generates e-mail notification or SNMP trap notification can be selected to limit the number of events to a specific priority level.

Customers can frequently resolve a simple problem themselves by using the information found in [Diagnosing a Problem on page 81](#). If the problem is unrecoverable, the customer must contact Overland-Tandberg Technical Support.

Library Error Message Content

When a library event occurs, the event is logged into Flash memory on the Library Control Board.

The library error log can be viewed on the Operator Control Panel by selecting **Service > View Error Status**. The log lists all of the library error messages in the order in which they occurred, starting with the most recent at the top.

The Remote Management Interface can display a log history summary of information, warning, and error events that have occurred by selecting **Service Library > Operator Interventions**. The summary can be filtered to display the operator intervention log for a

specific hardware component and specific event levels. The log is stored in memory on the Library Control Board. When the memory buffer is full, new events overwrite the oldest events. The log is not cleared from memory when power is turned OFF. The information displayed in the **Detail** panel for the selected operator intervention event comprises of:

- Index number of the event
- Date the event occurred
- Time the event occurred
- Unit in the library where the event occurred
- Event level
- Description of the event

The Remote Management Interface can also display a log history summary of errors that have occurred by selecting **Service Library > View Library Logs**. The error log is displayed with sense data information. The summary can be filtered to display errors with specific sense data code types. The information displayed in the **Detail** panel for the selected error comprises of:

- Index number of the error
- Date and time the error occurred
- Error code
- Description of the error

Diagnosing a Problem

Problem Area	Symptom	Possible Resolution
Cartridge	A cartridge is not ejecting from the drive.	<ol style="list-style-type: none"> 1. Try unloading the drive (Operator Control Panel: Commands > Unload). 2. Power cycle the library. 3. If the cartridge does not eject from the drive, contact Overland-Tandberg Technical Support.
	The cartridge case or tape inside the cartridge is damaged.	Replace the tape cartridge.
	Your cleaning cartridge expires.	Replace the cleaning cartridge.
	A barcode label cannot be read by the barcode reader.	<ol style="list-style-type: none"> 1. Export the suspect cartridge from the library. 2. Confirm that the barcode label is not damaged or missing. Replace the barcode label, if necessary. 3. Import the cartridge back into the library. 4. Inventory the library. <ul style="list-style-type: none"> • If no errors are reported, resume normal library operations. • If an error is reported, see Appendix B, "Error Codes."

Problem Area	Symptom	Possible Resolution
Cartridge Magazine	The magazine will not unlock after issuing the Unlock Magazine command from the Operator Control Panel.	<ol style="list-style-type: none"> 1. Power cycle the library. 2. Try unlocking the magazine again (Operator Control Panel > Unlock Magazine). <ul style="list-style-type: none"> • If the magazine does not unlock, see Unlocking the Cartridge Magazine Manually on page 88. <p>If the magazine does unlock, resume normal library operations.</p>
	<p>The magazine can only be partially removed from the library.</p> <p>The magazine seems stuck on something inside the library.</p>	<ol style="list-style-type: none"> 1. Verify that you have requested the library to unlock the entire magazine, not just the Mailslot (if enabled), then retry the operation. 2. Carefully pull the magazine out of the library. Stop if you feel any resistance (as if something is blocking the magazine inside the library). 3. If the magazine still cannot be removed from the library, contact Overland-Tandberg Technical Support.
Communication Functions	You are experiencing difficulty exercising some library functions (for example, updating firmware or logging in to the library remotely).	<ol style="list-style-type: none"> 1. If you have a recent backup of your configuration, proceed to the next step. If you do not, try to save one now (Remote Management Interface: Configure Library > Save/Restore). 2. If using a static IP address, make note of your library's IP address. If using DHCP, proceed to the next step. 3. Restore factory defaults (Operator Control Panel: Configuration > Set Default). 4. If using a static IP address, disable DHCP (the default setting) and enter the library IP address (Remote Management Interface: Configure Library > Network; Operator Control Panel: Configuration > Configure Network Settings). If using DHCP, proceed to the next step. 5. Restore the library configuration (Remote Management Interface: Configure Library > Save/Restore).

Problem Area	Symptom	Possible Resolution
Error Codes or TapeAlert Flags	The library issued an error code. An error message was received via email notification (if enabled).	<ol style="list-style-type: none"> 1. Make note of the error code. 2. Power cycle the library. <ul style="list-style-type: none"> • If the error reoccurs, see Appendix B, "Error Codes." • If the error does not reoccur, resume normal library operations.
	A TapeAlert flag was received.	<ol style="list-style-type: none"> 1. Make note of the TapeAlert flag. 2. Power cycle the library. <ol style="list-style-type: none"> a. If the TapeAlert reoccurs, see Appendix C, "TapeAlert Flags." b. If the TapeAlert does not reoccur, resume normal library operations.
	The error code represents an unrecoverable error.	Contact Overland-Tandberg Technical Support.
	You get repeated errors.	<ol style="list-style-type: none"> 1. Reset the library. 2. If the library is still reporting errors, power cycle the library. If no errors are reported, resume normal library operations. 3. If the library still fails, reset factory defaults. If no errors are reported, resume normal library operations. 4. If the problem persists, contact Overland-Tandberg Technical Support.
	You are experiencing a problem with your library and no error code was created.	<ol style="list-style-type: none"> 1. Run Library Verify to identify and resolve the problem. See Verify the Library on page 89. 2. If the problem persists, contact Overland-Tandberg Technical Support.
Firmware	The Library firmware does not complete the boot-up process and appears hung.	<p>Failure of the login screen to appear on the Operator Control Panel in 15 minutes indicates that the boot-up process is not completing.</p> <ol style="list-style-type: none"> 1. Power OFF the library and wait at least one minute before powering ON to recover from the problem. 2. If a library firmware update was just performed, try repeating the update procedure.
	All firmware (library and drive) is not at the latest level.	See Installation and Configuration Problems on page 86 .
Front Panel LEDs	One or more front panel LEDs is ON or blinking.	See Interpreting Front Panel LEDs on page 87 .
Host Attachment Interface	You are experiencing host attachment interface problems.	See Isolating Host Attachment Interface Problems on page 85 .
Installation and Configuration	You are experiencing trouble installing or configuring your library.	See Installation and Configuration Problems on page 86 .
ITDT	The Performance Test duration varies.	<p>Items affecting the duration of the test are:</p> <ul style="list-style-type: none"> • The level of adapter device driver • Your adapter model and type

Problem Area	Symptom	Possible Resolution
Library Not Booting	There is a blank Operator Control Panel/display. The display is stuck on initialization for extended period of time.	Failure of the login screen to appear on the Operator Control Panel within 15 minutes indicates that the boot process is not completing. <ol style="list-style-type: none"> 1. Power OFF the library and wait at least one minute before powering ON to recover from the problem. 2. If a library firmware update was just performed, try repeating the update procedure.
Logs	You are required to download the library log or drive log.	Using the Remote Management Interface, access the logs: <ul style="list-style-type: none"> • Library log: Service Library > Download Library Logs • Drive log: Service Library > Download Drive Logs
	You need to acquire library or drive information at the host.	See your host documentation.
Network Time Protocol (NTP)	The library time is not being updated by the NTP server.	Using the Remote Management Interface: <ol style="list-style-type: none"> 1. Disable NTP. 2. Set the time manually. 3. Enable NTP.
Power	If the power supply switch is ON and the library is OFF.	See Isolating Library Power Problems on page 84 .
Remote Management Interface	HTML error 404 appears on computer screen when trying to launch the Remote Management Interface.	See Isolating RMI Problems on page 85 .

Isolating Problems

Isolating Library Power Problems

1. Ensure the **power cord** is plugged in at the power supply and at the electrical outlet, then turn library power ON.
Feel for air flowing out of the cooling fan grill on the rear of the library. Power is good if air is flowing from the cooling fan grill.
2. If there is **no power**, do the following:
 - a. Plug the power cord into another electrical **outlet**.
 - b. Plug **another device** into the outlet to test.
 - c. If the outlet tests OK, try another **power cord**.
3. If you have verified that the electrical outlet and power cord works properly, but the power supply is still failing, replace the **library**.
4. If the power supply seems to be delivering power to the library; however, air does not flow from the power supply cooling fan grill on the rear of the library, replace the **library**.

Isolating Drive Problems

1. Ensure that the **drive firmware** is at the latest level.
Visit <http://docs.overlandstorage.com/neo>.

2. Cycle library **power**.
3. If the drive is experiencing permanent or temporary errors or if the Clean LED is lit on the front panel of the library, clean the **drive**.
4. From the OCP, run **Service > Library Verify**.
 - If the test fails, replace the **library**.
 - If the test passes, run **SAS Wrap Test**.
 - If the test passes, resume **normal** library operations.
 - If the test fails, replace the **library**.
5. Using the host interface test tool, ITDT, run the **Scan** function (s) to verify that the host application interface can detect the drive and the library. To further test the interface communication path, run the **Test Device** function (t), if available, after selecting the drive. This function will write/read data across the interface as well as sending a command to the drive to run the internal performance Read/Write test.
6. If the host tool, ITDT, cannot detect the **drive or library**, look for problems with the host interface cabling, the HBA, the device driver or the backup application software.

Isolating RMI Problems

1. Verify that you entered the **account name and password** correctly.
The account name and password are case sensitive.
2. Verify that other library users are **not entering commands** from the Remote Management Interface or Operator Control Panel at the same time you are issuing commands.
3. Ensure that library **firmware** is at the latest level.
Visit <http://docs.overlandstorage.com/neo>.
4. Ensure that the **Ethernet cable** is securely plugged in the rear of the library at the Ethernet port.
5. Ensure that the correct IP, netmask, and gateway addresses are keyed into the **network parameters**.
6. Ensure that the correct IP address is being used on the **web browser**.
7. If the Ethernet connection is a direct connection between the PC and the library, a special “**crossover**” Ethernet cable is required.

NOTE: On newer PCs, either straight through or crossover Ethernet cables may be used since the crossover requirement is provided internally.
8. Check the **Ethernet cable** carefully (or try another cable) and, if the cable is connected to a network hub or switch, try a **different port**.
9. If the Remote Management Interface is still malfunctioning, contact Overland-Tandberg Technical Support.

Isolating Host Attachment Interface Problems

After successfully exercising [Isolating Drive Problems on page 84](#), and more specifically **Service > Library Verify** (see [Verify the Library on page 89](#)) from the Operator Control Panel, the following procedures are suggested to help isolate the failure to properly establish connectivity to the Host Bus Adapter (HBA).

1. If not already performed, run **SAS Wrap Test** from the Operator Control Panel. The test requires that a proper Wrap Tool be installed at some point during the test procedure.
 - If the wrap test fails, replace the **library**, and skip to [Step 3](#).
 - Otherwise, continue with [Step 2](#) if the wrap test **passes**.
2. Use the **ITDT utility** to evaluate connectivity from the HBA through the cabling to the drive. ITDT does not require separate device drivers, thus the Operating System has the ability to scan and find all the LTO devices that are attached.
 - If ITDT **cannot** successfully locate the LTO drive, suspect cabling or HBA problems, and skip to [Step 4](#).
 - If ITDT **successfully** located the LTO drive, proceed to [Step 3](#).
3. If ITDT successfully locates the LTO devices, verify that the correct **application** device drivers and backup application software is properly installed.
4. Ensure that all the **required or latest** available Operating System files and/or updates (DLLs, PTFs, and so on) have been installed and applied.

Installation and Configuration Problems

Problems encountered during the installation of the library are usually caused by improper application software configuration errors or an incorrectly configured operating system. If the application software that you are using is not communicating with the library after installation, check the following:

- **HBA LUN 0/1 support** – A single ID will address both drive and library since the drive is LUN 0 and the library is LUN 1. These models require an HBA that supports LUN scanning which must be enabled at the HBA.
- **Cable connections** – Ensure that there are no bent pins on cables and that all connections are securely fastened.
- **Cables and interposers** – Ensure that library cables and interposers (if any) are not damaged (especially FC optical cables) and properly attached.
- **Backup application installation** – Refer to the documentation included with your backup application software for instructions on how to verify proper installation.
- **Device driver installation** – Ensure that the proper device driver, if applicable, is installed for the library.

NOTE: Many backup applications use their own drivers for the library and drive. Before installing a driver, make sure it will not be in conflict with the software. Contact your backup application vendor for this information.

Review the information in [Chapter 2, “Installation & Configuration,”](#) to determine if a step was missed or misread.

If you are still experiencing difficulty installing or configuring your library, contact Overland-Tandberg Technical Support.



IMPORTANT: Do not disassemble the library. The warranty on your library is voided if the unit is disassembled.

Interpreting Front Panel LEDs

Light emitting diodes (LEDs) on the front panel of the library provide a visual indication about the status of certain library components. The LEDs can sometimes communicate that a problem exists when operator interventions cannot.

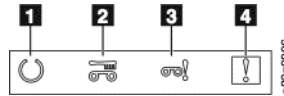

1	Ready/Activity LED	3	Attention LED
2	Cleaning LED	4	Error LED

Library Condition	Ready/Activity LED	Cleaning LED	Attention LED	Error LED	Message on Display
POST (Power ON Self Test)	Blinks 2 times per second	OFF	OFF	OFF	INITIALIZING... INVENTORY...
Magazine open	Blinks 2 times per second	OFF	OFF	OFF	PLEASE INSERT MAGAZINE
Magazine unlocked	Blinks 2 times per second	OFF	OFF	OFF	MAGAZINE UNLOCKED
Mailslot open	Blinks 2 times per second	OFF	OFF	OFF	PLEASE CLOSE I/O STATION
Mailslot unlocked	Blinks 2 times per second	OFF	OFF	OFF	I/O STATION UNLOCKED
Library firmware is being updated	Blinks 2 times per second	OFF	OFF	OFF	LOADER FIRMWARE UPDATING!
Drive firmware is being updated	Blinks 2 times per second	OFF	OFF	OFF	DRIVE FIRMWARE UPDATING!
Drive dump is being uploaded to host computer	Blinks 2 times per second	OFF	OFF	OFF	DRIVE DUMP DATA UPLOADING!
Library is offline	Blinks 2 times per second	OFF	OFF	OFF	OFFLINE
Cartridge is being moved	Blinks 1 time per second	OFF	OFF	OFF	READY
Library error occurred	ON	OFF	OFF	ON	*** CHK *** CODE: [XXXX]
Drive error occurred	ON	OFF	OFF	ON	DRIVE FAULT CODE: [X]
Cartridge error occurred	ON	OFF	ON	OFF	MEDIA FAULT CODE: [X]
Cleaning cartridge has expired	ON	OFF	ON	OFF	REPLACE CLEANING MEDIA

Library Condition	Ready/Activity LED	Cleaning LED	Attention LED	Error LED	Message on Display
Drive has requested to be cleaned	ON	ON	OFF	OFF	CLEAN DRIVE
Drive is being cleaned	ON	Blinks 1 time per second	OFF	OFF	CLEANING...
Library is online and ready to receive a command	ON	OFF	OFF	OFF	READY

Reseating Cables

To reseal external library cables, perform the following steps:

1. Locate the following **cables** on the rear panel of the library.
 - SAS attachment for the drive
 - Ethernet cable for connection to a network
 - Power supply cable
2. Check and **reseal**, if necessary, all of the cables connected to your library.
3. Verify that there is no damage to any **connector pins**.

Emailing Logs

Logs provide a summary of the current status, warnings, and errors in the library, and include configuration settings and information provided in Operator Interventions.

Download current logs of the library and drive when requested by your service representative. To email current logs:

1. Ensure that **no applications** are accessing the library. If a library operation is in progress, wait until it finishes before attempting to generate the logs.
2. Download the current library log from the Remote Management Interface by selecting **Service Library > Download Library Logs**, click **Refresh**, and click **Download**.
3. Download the current drive log from the Remote Management Interface by selecting **Service Library > Download Drive Logs**, click **Refresh**, and click **Download**.
4. When requested by Overland-Tandberg Technical Support, attach the **log** to an email message and send it to Overland for further diagnosis.

Unlocking the Cartridge Magazine Manually

This procedure is used to remove the cartridge magazine manually when, for example, the power is turned OFF or if the magazine fails to unlock in response to the Unlock Magazine command from the Operator Panel.

To unlock the cartridge magazine manually:

1. On the front panel, locate the **access hole** for the cartridge magazine locking release mechanism to the left of the Operator Control Panel (1).

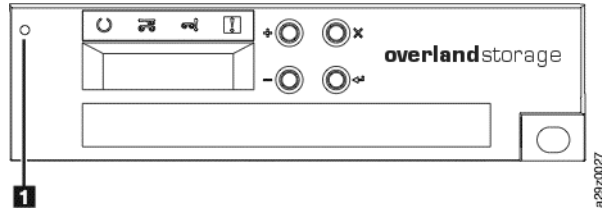

2. Insert the end of a **straightened paper clip**, or similar object, into the lock release access hole and gently push the lock mechanism to release the lock and eject the cartridge magazine.
3. If the mailslot is enabled, push the lock mechanism **twice** or push and hold the lock mechanism until the cartridge has been withdrawn far enough to clear the mailslot lock.
4. Remove the **cartridge magazine** from the front of the library.
If the magazine is stuck in the library and does not eject, contact Overland-Tandberg Technical Support.
5. Examine the magazine and cartridges for **damage**.
 - If there is damage to a cartridge, replace that cartridge.
 - If there is damage to the magazine, replace the magazine.

Verify the Library

After correcting the problem, run **Service > Library Verify** from the Operator Control Panel:

- If the test fails, replace the **library**.
- If the test passes, run **SAS Wrap Test**.
 - If the test passes, resume **normal** library operations.
 - If the test fails, replace the **library**.

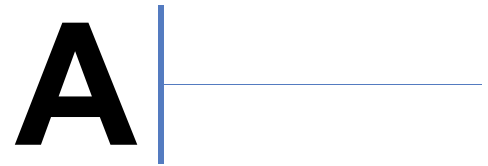

Specifications

Hardware Specifications

Form Factor	1U	2U
Height	Product alone: 45.6 mm	Product alone: 87.6 mm
	Packaged: 235 mm	Packaged: 248 mm
Width	Product alone: 444.5 mm	Product alone: 447.5 mm
	Packaged: 589 mm	Packaged: 598 mm
Depth	Product alone: 789.5 mm	Product alone: 740 mm
	Packaged: 989 mm	Packaged: 993 mm
Weight (library only)	1 HH drive unit: 11.4 kg	1 FH drive unit: 14.7 kg
		2 HH drive unit: 15.6 kg
Weight (with media)	1 HH drive unit: 13.1 kg	1 FH drive unit: 20.2 kg
		2 HH drive unit: 21.1 kg

Operational Specifications

Operating	Temperature	10 °C to 35 °C
	Max. temperature rise	10 °C / hour
	Humidity	20% RH to 80% R.H. (non-condensing)
	Maximum wet bulb	26 °C
	Max. humidity rise	10% / hour
	Altitude operating	0 to 10.000 ft. (3000 m) at 25 °C ambient

Non-Operating Storage and Shipping	Temperature	-30 °C to +60 °C
	Max. temperature rise	20 °C / hour
	Humidity	10% RH to 90% RH (non-condensing)
	Altitude	-22 to 33000 feet (-7 m to 10000 m)

Acoustical specifications:

Parameter	Measurement
Idling acoustical noise sound power level LwAD in Bels (1 Bel = 10 dB)	6.6
Maximum acoustical noise sound power level LwAD in Bels (1 Bel = 10 dB)	6.8

Electrical Specifications

Parameter	Measurement
Voltage	100 to 240 VAC (4.0 to 1.5 A)
Frequency	50 to 60 Hz
Power consumption	110 W

For additional installation information, see [“Installation Preparation” on page 20](#).

Product Environment

The NEO S-Series Tape Library is designed to operate in a general business environment.

The library meets the acoustical requirements for general business area Category 2D. Category 2D states that the library should be installed a minimum of 4 m (13 ft.) from a permanent work station.

To allow for service access, install the library a minimum of 0.9 m (3 ft.) from all obstacles.

The library is a precision computer peripheral. To ensure maximum longevity of your library, locate the library away from dust, dirt, and airborne particulates, as follows:

- Keep the library away from high-traffic areas, especially if the floor is carpeted. Carpeting harbors dust and people walking on the carpet can cause the carpet fibers and the dust to become airborne.
- Keep the library out of printer and copier rooms because of toner and paper dust. Additionally, do not store paper supplies next to the library.
- Keep the library away from moving air caused by doorways, open windows, fans, and air conditioners.

Ensure that the machine covers are always kept closed to minimize any contamination.

Supported Servers, Operating Systems, and Software

The NEO S-Series Tape Library is supported by a wide variety of servers (hosts), operating systems, adapters, and software. The supported attachments and software can change throughout the life cycle of the product.

To download the latest supported software, click this link.

https://ftp1.overlandtandberg.com/public/TDOVRL_Software_Compatibility_Matrix.pdf

Supported Device Drivers

NOTE: If you do not have internet access and you need information about device drivers, contact your Marketing Representative.

Device drivers enable the drive to interact with a variety of servers. To properly install a device driver (if required), refer to the drive installation technical bulletin on the NEO support website. For applications that use other device drivers, see that application's documentation to determine which drivers to use.

Follow this link to access technical bulletins and other driver documentation:

<https://www.overlandtandberg.com/knowledgebase/>

Go to *Tape Archive Solutions (NEO & LTO Drives)* to access the different documents.

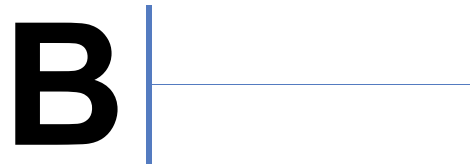

Error Codes

When an error occurs during operation of the NEO NEO S-Series library, the library stops the current operation and displays an error code on the Operator Control Panel.

When preparing to resolve an error code:

1. Record the error information displayed on the OCP or RMI screen.
2. If possible, cycle library power.

NOTE: When power cycling the library, wait 10 seconds after the power is switched OFF before powering to ON again.

3. Retry the operation.
 - If the error reoccurs, refer to the error codes in this appendix for information on resolving the error.
 - If the error does not reoccur, run Library Verify (see [Verify the Library on page 89](#)) or System Test before continuing with normal library operation.

Topics in Error Codes

- [Library Error Codes](#)
- [Drive Error Codes](#)
- [Remote Management Interface Error Messages](#)
- [Trap Definitions \(Types\)](#)

Library Error Codes

Code (H)	Description	Panel Indication	Action Required
0000	No valid error code information.	-	<ol style="list-style-type: none">1. Upgrade/reinstall firmware and try again.2. Cycle the power supply and try again.
0001	At power-on initialization, a firmware error was detected.	All 4 LEDs ON	<ul style="list-style-type: none">• If the problem is corrected, run Library Verify before resuming normal library operations.
0002	At power-on initialization, a RAM (base area) error was detected.	Ready/Activity LED ON and Error LED ON	<ul style="list-style-type: none">• If the problem persists, contact Overland-Tandberg Technical Support.
0003	At power-on initialization, a RAM (buffer area) error was detected.	CHK 0003	

Drive Error Codes

Code (H)	Description	Panel indication	Action Required
0200	Invalid data sent to drive. NAK detected.	CHK 0200	<ol style="list-style-type: none"> Reseat all cables. See Reseating Cables on page 88. Cycle the power supply and try again. <ul style="list-style-type: none"> If the problem is corrected, run Library Verify before resuming normal library operations. If the problem persists, contact Overland-Tandberg Technical Support.
0201	Timeout error occurred while waiting for response from drive.	CHK 0201	
0203	Drive disconnected.	CHK 0203	
0205	Drive busy.	CHK 0205	
0206	Command could not be executed because drive is not mounted.	CHK 0206	
020E	Drive error detected.	CHK 020E	
020F	Unsupported drive detected.	CHK 020F	
0222	Media could not be ejected because drive is in Prevent Medium Removal state.	CHK 0222	<ol style="list-style-type: none"> Release the drive Prevent Medium Removal state from the host. Reseat all cables. See Reseating Cables on page 88. Cycle the power supply and try again. <ul style="list-style-type: none"> If the problem is corrected, run Library Verify before resuming normal library operations. If the problem persists, contact Overland-Tandberg Technical Support.

Remote Management Interface Error Messages

Title	Message	Issuing Panel
Error	Users full.	User Access
	You cannot remove yourself.	User Access
Parameter Error	Login failure.	Login
	Unsupported update file.	Firmware Update
	Invalid parameter found in [***].	Configure Library
	Please input parameter of [***].	Configure Library
	Password parameter error.	User Access
	User name parameter error.	User Access
	Not enough role.	User Access
	A user name unmatched.	User Access
	A user is already existed.	User Access
	Users full.	User Access
	Flush ROM write error detected.	User Access
	User information access failure.	User Access

Trap Definitions (Types)

The NEO NEO S-Series supports the following types of SNMP traps.

Trap ID	Event Type	Description	Clean Drive LED	Attention LED	Error LED
1	Emergency	Drive error	-	-	ON
2		Library error	-	-	ON
21	Error	Drive error	-	-	ON
22		Library error	-	-	ON
51 (Drive) 52 (Library)	Warning	<ul style="list-style-type: none"> • Drive error • Library error • Endurance frequency attainment 	-	-	ON
53 (Drive)		Cleaning demand reception from drive	ON	-	-
54 (Library)		Cleaning cartridge demand for an exchange	-	ON	-
101 (Drive) 102 (Library)	Information	<ul style="list-style-type: none"> • Beginning of inventory • Change in library operation mode • Beginning of medium move • Completion of medium move • Library/Drive not ready • Library/Drive to online • Magazine unlock operation • Mailslot unlock operation 	-	-	-

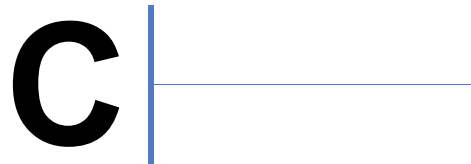

TapeAlert Flags

This appendix is intended to provide additional information to the reader about the tape library and tape drive. All error code and diagnostic information contained in this chapter cannot be accessed from the Operator Control Panel of the Library. The Operator Control Panel will, however, display other library error codes and drive error codes when problems occur. For a listing of Operator Control Panel error messages, see [Appendix B, “Error Codes.”](#)

TapeAlert is a standard that defines status conditions and problems experienced by devices such as tape drives, autoloaders, and libraries. The standard enables a server to read TapeAlert messages (called flags) from a tape drive. The server reads the flags from Log Sense Page 0x2E.

This library is compatible with TapeAlert technology, which provides error and diagnostic information about the drives and the library to the server. Because library and drive firmware may change periodically, the SNMP interface in the library does not require code changes if devices add additional TapeAlerts that are not supported today. However, should this occur the Management Information Block (MIB) is written to minimize impact to the SNMP monitoring station. At the time of this writing, the TapeAlert flags in this appendix correctly represent TapeAlerts that will be sent. The MIB file should not be taken to mean that all traps that are defined in the MIB will be sent by the library or that they will be sent in the future.

Topics in TapeAlert Flags:

- [Library Supported TapeAlert Flags](#)
- [Tape Drive Supported TapeAlert Flags](#)

Library Supported TapeAlert Flags

Flag Number	Flag Name	Type*	Description	Action Required
01	Library Hardware A	C	The library mechanism is having trouble communicating with the tape drive.	<ol style="list-style-type: none">1. Cycle the power supply and try again.2. If the problem persists, contact Overland-Tandberg Technical Support.
02	Library Hardware B	W	The media changer mechanism has a hardware fault.	
03	Library Hardware C	C	The media changer mechanism has a hardware fault that requires a reset to recover.	<ol style="list-style-type: none">1. Make sure the media changer and drives are not being used by any host, then reset the library from the front panel.2. If the problem persists, contact Overland-Tandberg Technical Support.

Flag Number	Flag Name	Type*	Description	Action Required
04	Library Hardware D	C	The library mechanism has a hardware fault that is not mechanism related, or requires power cycle to recover.	<ol style="list-style-type: none"> 1. Cycle the power supply and try again. 2. If the problem persists, contact Overland-Tandberg Technical Support.
06	Library Interface	C	The library has identified an interface fault.	<ol style="list-style-type: none"> 1. Check all cables and cable connections. 2. Restart the operation. 3. If the problem persists, contact Overland-Tandberg Technical Support.
08	Library Maintenance	W	Library preventative maintenance required.	Preventative maintenance of the library is required. Consult the library user's manual for device-specific preventative maintenance tasks.
12	Library Stray Tape	C	A cartridge has been left in the drive inside the library by a previous hardware fault.	<ol style="list-style-type: none"> 1. Try unloading the cartridge from the drive using the Operator Control Panel or Remote Management Interface. <ul style="list-style-type: none"> • If the cartridge unloads, move the cartridge from the drive to the mailslot. Remove the cartridge and inspect for damage. If not damaged, return the cartridge to the library. Run Library Verify before resuming normal library operations. • If the cartridge did not unload from the drive, cycle the power supply and try again. 2. If the problem persists, contact Overland-Tandberg Technical Support.
13	Library Pick Retry	W	There is a potential problem with the cartridge loader picking a cartridge from a drive or slot.	No action is required. This flag is cleared when the next move command is received.
14	Library Place Retry	W	There is a potential problem with the cartridge loader placing a cartridge into a slot.	
15	Drive Load Retry	W	There is a potential problem with the cartridge loader or drive when placing a cartridge into a drive.	
16	Library Door	W	The operation has failed because the library door is open.	Clear any obstructions from the library door. Close the library door. This flag is cleared when the door is closed.
17	Library Mailslot	C	Mechanical problem with the mailslot.	There is a mechanical problem with the library mailslot.
18	Library Magazine	C	Library magazine not present.	<p>The library cannot operate without the magazine.</p> <ol style="list-style-type: none"> 1. Insert the magazine into the library. 2. Restart the operation.
19	Library Security	W	Library security has been compromised.	The door was opened then closed during an operation.

Flag Number	Flag Name	Type*	Description	Action Required
21	Library Offline	I	Library manually turned offline.	The library has been manually turned offline and is unavailable for use.
22	Library Drive Offline	I	Library turned internal drive offline.	The drive inside the library has been taken offline. This is for information purposes only. No action is required.
23	Library Scan Retry	W	There is a potential problem with the barcode label of the scanner hardware in the library mechanism.	No action is required.
24	Library Inventory	C	The library has detected an inconsistency in its inventory	<ul style="list-style-type: none"> • Redo the library inventory to correct inconsistency. • Restart the operation.
27	Cooling Fan Failure	W	One or more fans inside the library have failed.	This flag is cleared when all fans are working again.
28	Power Supply	W	PSU failure inside the library subsystem.	The power supply has failed inside the library. Contact Overland-Tandberg Technical Support.

* **C** = Critical: Needs immediate action. **W** = Warning: Action to be taken. **I** = Information: Information for user.

Tape Drive Supported TapeAlert Flags

Flag Number	Flag Name	Description	Action Required
3	Hard error	Set for any unrecoverable read, write, or positioning error (this flag is set in conjunction with flags 4, 5, or 6).	See the action required for Flag Number 4, 5, or 6 in this table.
4	Media	Set for any unrecoverable read, write, or positioning error that is due to a faulty tape cartridge.	Replace the tape cartridge.
5	Read failure	Set for any unrecoverable read error where the isolation is uncertain and failure could be due to a faulty tape cartridge or drive hardware.	If Flag Number 4 is also set, the tape cartridge is defective. Replace the tape cartridge.
6	Write failure	Set for any unrecoverable write or positioning error where isolation is uncertain and failure could be due to a faulty tape cartridge.	<p>If Flag Number 9 is also set, make sure that the write-protect switch is set so that data can be written to the tape. See Write Protecting Tape Cartridges on page 27.</p> <p>If Flag Number 4 is also set, the tape cartridge is defective. Replace the tape cartridge.</p>
7	Media life	Set when the tape cartridge reaches its end of life (EOL).	<ol style="list-style-type: none"> 1. Copy the data to another tap cartridge. 2. Discard the old (EOL) tape.
8	Not data grade	Set when the tape cartridge is not data-grade. Any data that you back up to the tape is at risk.	Replace the tape cartridge with a data-grade tape cartridge.
9	Write protect	Set when the tape drive detects that the tape cartridge is write-protected.	Ensure that the cartridge's write-protect switch is set so that data can be written to the tape. See Write Protecting Tape Cartridges on page 27 .

Flag Number	Flag Name	Description	Action Required
10	No removal	Set when the tape drive receives an UNLOAD command after the server prevented the tape cartridge from being removed.	Refer to the documentation for your server's operating system.
11	Cleaning media	Set when a cleaning tape is loaded into the drive.	No action required. Status only.
12	Unsupported format	Set when a non-supported cartridge type is loaded into the drive or when the cartridge format has been corrupted.	Replace the invalid cartridge with a supported tape cartridge.
14	Unrecoverable snapped tape	Set when the operation failed because the tape in the drive snapped.	Do not attempt to extract the tape cartridge. Contact Overland-Tandberg Technical Support.
15	Cartridge memory chip failure	Set when a cartridge memory (CM) failure is detected on the loaded tape cartridge.	Replace the tape cartridge.
16	Forced eject	Set when a tape cartridge was unloaded manually while the drive was reading or writing.	No action required. Status only.
17	Media loaded is Read-only format	Set when a cartridge marked as read-only is loaded into the drive. The flag is cleared when the cartridge is ejected.	No action required. Status only.
18	Tape directory corrupted in cartridge memory	Set when the tape drive detects that the tape directory in the cartridge memory has been corrupted.	Re-read all data from the tape to rebuild the tape directory.
19	Nearing media life	Set when the tape cartridge is nearing its specified end of life. It is cleared when the cartridge is removed from the drive.	<ol style="list-style-type: none"> 1. Copy the data to another tape cartridge. 2. Replace the tape cartridge.
20	Clean now	Set when the tape drive detects that it needs cleaning.	Clean the tape drive.
21	Clean periodic	Set when the tape drive detects that it needs routine cleaning.	Clean the tape drive as soon as possible. The drive can continue to operate, but requires cleaning soon.
22	Expired cleaning media	Set when the tape drive detects a cleaning cartridge that has expired.	Replace the cleaning cartridge.
23	Invalid cleaning cartridge	Set when the drive expects a cleaning cartridge to be loaded and the loaded cartridge is not a cleaning cartridge.	Use a valid cleaning cartridge.
30	Hardware A	Set when a hardware failure occurs that requires that you reset the tape drive to recover.	Contact Overland-Tandberg Technical Support.
31	Hardware B	Set when the tape drive fails its internal Power-On Self-Tests (POSTs).	Note the error code on the single-character display and contact Overland-Tandberg Technical Support.
32	Interface	Set when the tape drive detects a problem with the host interface.	Contact Overland-Tandberg Technical Support.

Flag Number	Flag Name	Description	Action Required
33	Eject media	Set when a failure occurs that requires the tape cartridge to be unloaded from the drive.	Unload the tape cartridge, then reinsert and restart the operation. If this fails, use different media.
34	Download fail	Set when an FMR image is unsuccessfully downloaded to the tape drive via the SAS interface.	Check the FMR image is correct. If necessary, download the correct FMR image.
36	Drive temperature	Set when the drive temperature sensor indicates that the drive's temperature exceeds the recommended temperature of the library.	Contact Overland-Tandberg Technical Support.
37	Drive voltage	Set when the drive detects power supply voltages that approach or exceed the specified voltage limits.	Contact Overland-Tandberg Technical Support.
38	Predictive failure of drive hardware	Set when a hardware failure of the tape drive is predicted.	Contact Overland-Tandberg Technical Support.
39	Diagnostics required	Set when the tape drive detects a failure that requires diagnostics for isolation.	Contact Overland-Tandberg Technical Support.
51	Tape directory invalid at unload	Set when the tape directory on the tape cartridge that was previously unloaded is corrupted. The file-search performance is degraded.	Use your backup software to rebuild the tape directory by reading all the data.
52	Tape system area write failure	Set when the tape cartridge that was previously unloaded could not write its system area successfully.	Copy the data to another tape cartridge, then discard the old tape cartridge.
53	Tape system area read failure	Set when the tape system area could not be read successfully at load time.	Copy the data to another tape cartridge, then discard the old tape cartridge.
55	Load failure	Set when a hardware malfunction prevents the tape cartridge from being loaded into the drive, or when a tape cartridge is stuck in the drive.	<p>If the tape cartridge will not load in the drive:</p> <ol style="list-style-type: none"> 1. Remove the tape cartridge from the library and inspect it for damage. If damaged, discard it. 2. Insert another tape cartridge into the tape drive. 3. If the problem persists, contact Overland-Tandberg Technical Support. <p>If the tape cartridge is stuck in the drive:</p> <ol style="list-style-type: none"> 1. Attempt to unload the tape from the drive using the host backup application that is currently using the drive, or via the remote or local UI. 2. If the cartridge will still not unload, contact Overland-Tandberg Technical Support.

Flag Number	Flag Name	Description	Action Required
56	Unload failure	Set when a drive hardware error prevents the tape cartridge from being unloaded from the tape drive, or when the tape cartridge is stuck in the drive.	<ol style="list-style-type: none"> 1. Unload the cartridge from the drive using the Operator Control Panel or the Remote Management Interface. 2. Try a power cycle of the entire library. This causes the drive to reset and attempt to rewind and unload when power is restored. If the cartridge unloads, remove it from the library and inspect it. If damaged, discard it. 3. Try to unload the cartridge from the drive again using the Operator Control Panel or the Remote Management Interface. 4. If the cartridge will still not unload from the drive, contact Overland-Tandberg Technical Support.
59	WORM Media integrity check failed	Set when the drive determines that the data on the tape is suspect from a WORM point of view.	<ol style="list-style-type: none"> 1. Copy the data to another WORM tape cartridge. 2. Discard the old WORM tape.
60	WORM Media overwrite attempted	Set when the drive rejects a write operation because the rules for allowing WORM writes have not been met. Data can only be appended to WORM media. Overwrites to WORM media are not allowed.	Append the information on a WORM tape cartridge or write the data to a non-WORM cartridge.



Master Glossary & Acronym List

NOTE: This is a general Overland-Tandberg glossary and acronym list. Not all items may be found in this document or be used by this product.

1000BASE-T

1000BASE-T (also known as IEEE 802.3ab) is a standard for gigabit Ethernet over copper wiring. It requires, at a minimum, Category 5 cable (the same as 100BASE-TX), but Category 5e (Category 5 enhanced) and Category 6 cable may also be used and are often recommended. 1000BASE-T requires all four pairs to be present and is far less tolerant of poorly installed wiring than 100BASE-TX.

Address

An address is a data structure or logical convention used to identify a unique entity, such as a particular process or network device.

ADI

Short for *Automation/Drive Interface*. Media changer (automation) devices use a private communication link for monitoring and controlling removable medium devices (drives). The standard specifies a protocol for transporting commands, data, and status between automation devices and the drives.

Algorithm

A sequence of steps designed to solve a problem or execute a process.

ATA

Short for *Advanced Technology Attachment*. A standard interface for connecting storage devices to a PC.

Authentication

The validation of a user's identity by requiring the user to provide a registered login name and corresponding password.

Autonegotiation

An Ethernet feature that automatically negotiates the fastest Ethernet speed and duplex setting between a port and a hub or switch. This is the default setting and is recommended.

Autosensing

An Ethernet feature that automatically senses the current Ethernet speed setting.

Barcode

The machine-readable representation of a product code. Barcodes are read by a scanner that passes over the code and registers the product code. The width of black lines and white spaces between varies. Combinations of lines and spaces represent characters. Overland uses 3-of-9 code (Code 39) where each character is represented by 9 bars, 3 of which are wide.

Bridging

Devices that connect and pass packets between two network segments that use different communications protocol.

Bus or Channel

A common physical path composed of wires or other media, across which signals are sent from one part of a computer to another. A channel is a means of transferring data between modules and adapters, or between an adapter and SCSI devices. A channel topology network consists of a single cable trunk that connects one workstation to the next in a daisy-chain configuration. All nodes share the same medium, and only one node can broadcast messages at a time.

CA

Short for *Certificate Authority*. A trusted third-party in a network that issues and manages security credentials.

Cat 5 Cable

Short for *Category 5*, it is network cabling that consists of four twisted pairs of copper wire terminated by 8P8C modular connectors. CAT 5 cabling supports frequencies up to 100 MHz and speeds up to 100 Mbps. It can be used for ATM, token ring, 100BASE-T, and 10BASE-T networking.

Cat 5 is based on the EIA/TIA 568 Commercial Building Telecommunications Wiring Standard developed by the Electronics Industries Association as requested by the Computer Communications Industry Association in 1985.

Cat 6 Cable

Short for *Category 6*, it is network cabling that consists of four twisted pairs of copper wire terminated by 8P8C modular connectors made to higher standards that help reduce noise caused by crosstalk and system noise. The ANSI/TIA-568-B.2-1 specification states the cable may be made with 22 to 24 AWG gauge wire, so long as the cable meets the specified testing standards.

It is designed for Gigabit Ethernet that is backward compatible with the Category 5/5e and Category 3 cable standards. Cat 6 features more stringent specifications for crosstalk and system noise. The cable standard provides performance of up to 250 MHz and is suitable for 10BASE-T, 100BASE-TX, and 1000BASE-T (Gigabit Ethernet).

Channel

A communications path between two computers or devices.

Checksum

The result of adding a group of data items that are used for checking the group. The data items can be either numerals or other character strings treated as numerals during the checksum calculation. The checksum value verifies that communication between two devices is successful.

default gateway

The router used when there is otherwise no known route to a given subnet.

DHCP

Short for *Dynamic Host Configuration Protocol*. A communications protocol that lets network administrators centrally manage and automate the assignment of IP addresses on a computer network. Each system that connects to the internet/intranet needs a unique IP address.

Disaster Recovery

A strategy that allows a company to return to normal activities after a catastrophic interruption. Through failover to a parallel system or by restoration of the failed system, disaster recovery restores the system to its normal operating mode.

DNS

Short for *Domain Name Service*. A network service that translates domain names into IP addresses using a server that maintains a mapping of all host names and IP addresses. Normally, this mapping is maintained by the system administrator, but some servers support dynamic mappings.

Domain

A set of network resources in Windows 2000/2003/2008, such as users and groups of users. A domain may also include multiple servers on the network. To gain access to these network resources, the user logs into the domain.

Domain Name

The ASCII name that identifies the domain for a group of computers within a network.

Ethernet

The most widely installed LAN technology. 100BASE-T Ethernet provides transmission speeds of up to 100 Mbps. Fast Ethernet or 1000BASE-T provides transmission speeds up to 1000 Mbps and is typically used for LAN backbone systems, supporting workstations with 100BASE-T cards. Gigabit Ethernet (GbE) provides an even higher level of backbone support at 1000 Mbps (one Gigabit or one billion bits per second).

Ethernet Address

The unique six-digit hexadecimal (0-9, A-F) number that identifies the Ethernet interface.

Ethernet Port

The port on a network card to provide Ethernet access to the computer.

Event

Any significant occurrence or error in the system that may require notifying a system administrator or adding an entry to a log.

F_Port

A *Fabric* port within a Fibre Channel switch that provides a point-to-point link to a single N_Port. F_Ports are intermediate ports in virtual point-to-point links between end ports. For example, N_Port to F_Port to F_Port to N_Port using a single Fibre Channel fabric switch.

Fabric

A Fabric is a Fibre Channel (FC) that allows an active intelligent interconnection scheme to connect devices. Everything between the ports on an FC is called the Fabric. The Fabric is most often a switch or series of switches that takes the responsibility for routing.

FC-AL

Short for *Fibre Channel Arbitrated Loop*. An FC-AL is a Fibre Channel network in which up to 126 systems and devices are connected in a loop topology, with each transmitter connecting to the receiver of the device on its logical right. The Fibre Channel Arbitrated Loop protocol used for transmission is different from Fibre Channel switched and point-to-point protocols. Multiple FC-AL loops can be connected via a fabric switch to extend the network.

Fibre Channel

Fibre Channel (FC) is a gigabit-speed network technology which transports SCSI commands over Fibre Channel networks. Fibre Channel was primarily concerned with simplifying the connections and increasing distances, but later designers added the goals of connecting SCSI disk storage, providing higher speeds and far greater numbers of connected devices.

Firmware

Software stored in read-only memory (ROM) or programmable ROM (PROM). Firmware is often responsible for the behavior of a system when it is first switched on.

FL_port

A *Fabric Loop* port within a Fibre Channel switch that is capable of Fibre Channel Arbitrated Loop operations and is connected to one or more NL_Ports via a Fibre Channel Arbitrated Loop. An FL_Port becomes a shared entry point for public NL_Port devices to a Fibre Channel fabric. FL_Ports are intermediate ports in virtual point-to-point links between end ports that do not reside on the same loop, for example NL_Port to FL_Port to F_Port to N_Port through a single Fibre Channel fabric switch.

FTP

Short for *File Transfer Protocol*. A standard internet protocol that provides a way to exchange files between computers on the internet.

Full-duplex

A type of transmission that allows communicating systems to both transmit and receive data simultaneously.

Gateway

The hardware or software that bridges the gap between two network subnets. It allows data to be transferred among computers that are on different subnets.

Gigabit Ethernet

Also known as GigE or GbE, this Ethernet standard uses a one Gigahertz (1000 Hz) clock rate to move data.

HBA

Short for *Host Bus Adapter*. An HBA is an I/O adapter that sits between the host computer's bus and the Fibre Channel loop and manages the transfer of information between the two channels. To minimize the impact on host processor performance, the HBA performs many low-level interface functions automatically or with minimal processor involvement.

Half-duplex

A type of transmission that transfers data in one way at a time.

Host Name

The unique name by which a computer is known on a network. It is used to identify the computer in electronic information interchange.

Hot Swapping

The ability to add or remove powered-off tape drives to or from a system without the need to power down or interrupt client access to filesystems. Not all components are hot-swappable. Please read installation and maintenance instructions carefully.

HTTP

Short for *Hypertext Transfer Protocol*. An application protocol for transferring files (text, graphic images, sound, video, and other multimedia files) over TCP/IP on the World Wide Web.

HTTPS

Short for *Hypertext Transfer Protocol Secure*. The HTTP protocol using a Secure Sockets Layer (SSL). SSL provides data encryption, server authentication, message integrity, and client authentication for any TCP/IP connection.

I/E Element

See [Mail Slot](#).

Initiator Device

An initiator normally runs on a host computer. It may be either a software driver or a hardware plug-in card, often called a Host Bus Adapter (HBA). A software initiator uses one of the computer's Ethernet ports for its physical connection, whereas the HBA will have its own dedicated port.

IP

Short for *Internet Protocol*. The unique 32-bit value that identifies the location of the server. This address consists of a network address, optional subnetwork address, and host address. It displays as four addresses ranging from 1 to 255 separated by periods.

Kerberos

A secure method for authenticating a request for a service used by ADS. Kerberos lets a user request an encrypted "ticket" from an authentication process that can then be used to request a service from a server. The user credentials are always encrypted before they are transmitted over the network.

In Windows 2000/XP, the domain controller is the Kerberos server. The Kerberos key distribution center (KDC) and the origin of group policies are applied to the domain.

KMIP

Short for *Key Management Interoperability Protocol*. A client/server communication protocol for storage and maintenance of key, certificate, and secret objects.

LAN

Short for *Local Area Network*. A network connecting computers in a relatively small area such as a building.

LCD

Short for *Liquid Crystal Display*. An electronic device that uses liquid crystal to display messages.

LDAP

Short for *Lightweight Directory Access Protocol*. An open, vendor-neutral, industry standard application protocol for accessing and maintaining distributed directory information services over an Internet Protocol (IP) network.

LED

Short for *Light-Emitting Diode*. An LED is a type of diode that emits light when current passes through it. Visible LEDs are used as indicator lights on electronic devices.

Linux

A Unix-like operating system that was designed to provide personal computer users a free or very low-cost operating system comparable to traditional and usually more expensive Unix systems.

LTO

Short for *Linear Tape-Open*, a technology that was developed jointly by HP, IBM, and Certance (Seagate) as an open standards. It is ideally suited for backup, restore, and archive applications, and provides reliability in both stand-alone and automated environments. The tape cartridges go by the label "Ultrium."

- Ultrium generation 3 (LTO-3) cartridge – up to 800 GB capacity and a transfer rate of 80 MB/s using 2.0:1 compression.
- Ultrium generation 4 (LTO-4) cartridge – up to 1.6 TB capacity and a transfer rate of 120 MB/s using 2.0:1 compression.
- Ultrium generation 5 (LTO-5) cartridge – up to 3.0 TB capacity and a transfer rate of 280 MB/s using 2.0:1 compression.
- Ultrium generation 6 (LTO-6) cartridge – up to 6.25 TB capacity and a transfer rate of 400 MB/s using 2.5:1 compression.
- Ultrium generation 7 (LTO-7) cartridge – up to 15.0 TB capacity and a transfer rate of 750 MB/s using 2.5:1 compression.
- Ultrium generation 8 (LTO-8) cartridge – up to 30.0 TB capacity and a transfer rate of 750 MB/s using 2.5:1 compression.
- Ultrium generation 9 (LTO-9) cartridge – up to 45.0 TB capacity and a transfer rate of 750 MB/s using 2.5:1 compression.

LUN

Short for *Logical Unit Number*. A SCSI or Fibre Channel device identifier. LUN is a subdivision of a SCSI target.

LVD

Short for *Low Voltage Differential*. LVD is a method of powering SCSI cables that will be formalized in the SCSI-3 specifications. LVD uses less power than the current differential drive (HVD), is less expensive, and allows for higher speeds such as those of Ultra-2 SCSI. LVD requires 3.3 volts (versus 5 volts for HVD).

MAC Address

Short for *Media Access Control address*, a hardware address that uniquely identifies each node of a network. In the Open Systems Interconnection (OSI) model, one of two sublayers of the Data Link Control layer concerned with sharing the physical connection to the network among several computers. Each Ethernet port has a unique MAC address.

Mail Slot

A configurable import/export slot or magazine to provide a means of exchanging tape media while the unit is still operating.

Mapping table

A table indexed by sequential LUN values, indicating the selected BUS:TARGET:LUN devices. Mapping tables are used by routers and bridges like the GEOi to perform Ethernet-to-SCSI pathing.

MD5 Algorithm

MD5 is a way to verify data integrity, and is much more reliable than checksum and many other commonly used methods.

MIB

Short for *Management Information Base*. A formal description of a set of network objects that can be managed using the Simple Network Management Protocol (SNMP). The format of the MIB is defined as part of SNMP.

N_Port

A *Node* port connects via a point-to-point link to either a single N_Port or a single F_Port. N_Ports handle creation, detection, and flow of message units to and from the connected systems. N_Ports are end ports in virtual point-to-point links through a Fabric. For example, N_Port to F_Port to F_Port to N_Port using a single Fibre Channel fabric switch.

NIC

Short for *Network Interface Card*. A board that provides network communication capabilities to and from a computer.

NIS

Short for *Network Information Service*. It is a client–server directory service protocol for distributing system configuration data such as user and host names between computers on a computer network. Sun Microsystems developed NIS; the technology is licensed to virtually all other Unix vendors.

NL_port

A *Node Loop* port is capable of arbitrated loop functions and protocols. An NL_Port connects via an arbitrated loop to other NL_Port and at most a single FL_Port. NL_Ports handle creation, detection, and flow of message units to and from the connected systems. NL_Ports are end ports in virtual point-to-point links through a fabric, for example NL_Port to F_Port to F_Port to N_Port using a single Fibre Channel fabric switch. In the absence of a fabric switch FL_Port, NL_Ports can communicate with other NL_Ports in virtual point-to-point links through a FC-AL open loop circuit often through FC-AL (Arbitrated Loop) hub or loop switch devices.

NTP

Short for *Network Time Protocol*. A protocol for synchronizing the system clocks of computers over a packet-switched network.

NVRAM

Abbreviation of *Non-Volatile Random Access Memory*, a type of memory that retains its contents when power is turned off.

OCP

The *Operator Control Panel* is the front panel of a NEO XL-Series Base Module. It consists of an LCD display, navigation buttons, operation buttons, LEDs, and USB port.

Permissions

A security category, such as no access, read-only, or read-write, that determines what operations a user or group can perform on folders or files.

Port Name

This is an eight-byte hexadecimal number, uniquely identifying a single host [HBA](#) port. It incorporates the World Wide Name and two additional bytes that are used to specify the format and indicate the port number.

Protocol

A standardized set of rules that specifies the format, timing, sequencing, and/or error checking for data transmissions.

PTP

Short for *Point-to-Point*. PTP is the common mode of attachment to a single host. PTP is sometimes used to attach to a Fibre Channel switch for [SAN](#) connectivity.

RMI

The *Remote Management Interface* is a web interface for a NEO XL-Series library that provides access via a browser to all the library configurable features, includes online help, and is easier to use than the OCP.

Router

A router is a device that enables connectivity between Ethernet network segments.

SAN

Short for *Storage Area Network*. Data storage connected to a network that provides network clients access to data using block level protocols. To the clients, the data storage devices appear local rather than remote. An iSCSI SAN is sometimes referred to as an IP-SAN.

SAS

Short for *Serial Attached SCSI*. It is a point-to-point serial protocol that replaces parallel SCSI bus technology (multidrop) and uses the standard SCSI command set. It has no termination issues, supports up to 16,384 devices (using expanders), and eliminates clock skew. It consists of an Initiator that originates device service requests, a Target containing logical units that receives device service requests, and a Service Delivery Subsystem that transmits information between the Initiator and the Target.

SCSI

Short for *Small Computer System Interface*. SCSI is an industry standard for connecting peripheral devices and their controllers to an initiator. Storage devices are daisy-chained together and connected to a host adapter. The host adapter provides a shared bus that attached peripherals use to pass data to and from the host system. Examples of devices attached to the adapter include disk drives, CD-ROM discs, optical disks, and tape drives. In theory, any SCSI device can be plugged into any SCSI controller.

SCSI addressing

Each device supported by a SCSI adapter has its own unique SCSI address, which dictates the device's priority when arbitrating for access to the SCSI bus. A SCSI address of 7 has the highest priority. For a fast/wide SCSI adapter that supports up to 16 devices, the next highest priority address is 6, then 5, 4, 3, 2, 1, 0, 15, 14, 13, 12, 11, 10, 9, and 8. The narrow SCSI adapter supports up to eight devices, including itself. The SCSI address 7 has the highest priority, followed by 6, 5, 4, 3, 2, 1, and 0.

SCSI bus

A SCSI bus provides a means of transferring data between SCSI devices. A SCSI bus is either an 8- or 16-bit bus that supports up to 8 or 16 devices, including itself. The bus can consist of any mix of initiators and targets, with the requirement that at least one initiator and one target must be present.

SCSI device

A SCSI device is a single unit on a SCSI bus that originates or services SCSI commands. A SCSI device is identified by a unique SCSI address. SCSI devices can act as initiators or targets.

SCSI port

A SCSI port is an opening at the back of a router that provides connection between the SCSI adapter and SCSI bus.

SMB

Short for *Server Message Block*. A protocol for Windows clients. SMB uses the TCP/IP protocol. It is viewed as a complement to the existing internet application protocols such as FTP and HTTP. With SMB, you can access local server files, obtain read-write privileges to local server files, share files with other clients, and restore connections automatically if the network fails.

SMTP

Short for *Simple Mail Transfer Protocol*. A TCP/IP protocol used for sending and receiving email.

SNTP

Short for *Simple Network Time Protocol*. A TCP/IP protocol used for clock synchronization between computer systems over data networks.

SNMP

Short for *Simple Network Management Protocol*. A system to monitor and manage network devices such as computers, routers, bridges, and hubs. SNMP views a network as a collection of cooperating, communicating devices, consisting of managers and agents.

SSH

Short for *Secure Shell*. A service that provides a remote console for special system administration and customer support access to the server. SSH is similar to telnet but more secure, providing strong encryption so that no passwords cross the network in clear text.

SSL

Short for *Secure Sockets Layer*. A protocol for managing the security of a message sent on the internet. It is a type of technology that provides data encryption, server authentication, message integrity, and client authentication for any TCP/IP connection.

Standalone

A network bonding mode which treats each port as a separate interface. This configuration should be used only in multihomed environments in which network storage resources must reside on two separate subnets.

Static IP Address

An IP address defined by the system administrator rather than by an automated system, such as DHCP.

Storage Area Network

See [SAN](#).

Subnet Mask

A portion of a network that shares a common address component. On TCP/IP networks, subnets are all devices with IP addresses that have the same prefix.

Tape Cartridge

A magnetically coated strip of plastic in a plastic housing on which data can be encoded. Storing data on tapes is considerably cheaper than storing data on disks. Tapes also have large storage capacities, extending up to hundreds of gigabytes. They are generally used for long-term storage and backup, or for transporting large amounts of data. Tapes come in a variety of sizes and formats.

Tape Drive

A device, that reads data from and writes it onto a tape.

TCP/IP

Short for *Transmission Control Protocol/Internet Protocol*. The basic protocol used for data transmission over the internet.

Telnet

A terminal emulation program for TCP/IP networks such as the internet. The Telnet program runs on a computer and connects it to a server on the network. You enter commands through the Telnet program and they will be executed as if you were entering them directly on the server console. This enables you to control the server and communicate with other servers on the network. To start a Telnet session, you must log in to a server by entering a valid user name and password. Telnet is a common way to remotely control Web servers.

Topology

Logical layout of the parts of a computer system or network and their interconnections. There are two types of topology: physical and logical. The physical topology of a network refers to the configuration of cables, computers, and other peripherals. Logical topology is the method used to pass the information between workstations.

Trap

A signal from a device informing an SNMP management program that an event has occurred.

U

A standard unit of measure for designating the height in computer enclosures and rack cabinets. One U equals 1.75 inches. For example, a 3U server chassis is 5.25 inches high.

UDP

Short for *User Datagram Protocol*. A communications protocol for sending messages between computers in a network that uses the Internet Protocol (IP). UDP is an alternative to the Transmission Control Protocol but, unlike TCP, does not guarantee reliability or ordering of data packets.

UPS

Short for *Uninterruptible Power Supply*. A device that allows a computer to keep running for a short time when the primary power source is lost. It also provides protection from power surges. A UPS device contains a battery that starts when the device senses a loss of power from the primary source.

URL

Short for *Uniform Resource Locator*. A Web address.

USB Port

USB is short for *Universal Serial Bus*. A USB port is a hardware interface for low-speed peripherals such as the keyboard, mouse, joystick, scanner, printer, and telephony devices.

VLAN

Short for *Virtual LAN*. It consists of a network of computers that behave as if they are connected to the same wire - even though they may actually be physically connected to different segments of a LAN.

Web Management Interface

A Web-based utility used for configuration and ongoing maintenance, such as monitoring server conditions, configuring email alerts for key events, or for SNMP management.

Windows Domain Authentication

Windows-based networks use a domain controller to store user credentials. The domain controller can validate all authentication requests on behalf of other systems in the domain. The domain controller can also generate encrypted challenges to test the validity of user credentials. Other systems use encrypted challenges to respond to CIFS/SMB clients that request access to a share.

WINS

Short for *Windows Internet Naming Service*. The server that locates network resources in a TCP/IP-based Windows network by automatically configuring and maintaining the name and IP address mapping tables.

Workgroup

A collection of computers that are grouped for sharing resources such as data and peripherals over a LAN. Each workgroup is identified by a unique name.

Symbols

> (menu flow indicator) 7

A

admin password default 18
alert definitions 6
Attention LED 80

B

barcode guidelines 26
barcode label 25
barcode label position 26

C

Cartridge Memory Service screen 75
Clean Drive Service screen 74
cleaning cartridge 29
Configuration Screens in RMI 61
conventions, typographical 6
customer support 9

D

data cartridge 25
Date/Time Configuration screen 67
default settings 18
device drivers 92
Drive Configuration screen 63
Drive Diagnostic Service screen 72

E

Email Notification Configuration screen 68
error codes 93
Error LED 80
Ethernet port LEDs 17

F

factory defaults 82
Fibre Channel connections 21
Firmware Service screen 72
front panel
 components 13
 LEDs 87

G

General Diagnostic Service screen 71

H

host bus adapter (HBA) 21

I

installation in rack 20
Inventory Operations screen 70

L

LEDs
 front panel 87
library controller 17
library error log 80
library interfaces 18
Library Logs Service screen 73
License Key Configuration screen 62
location criteria 20
Log Configuration screen 68
Logical Libraries Configuration screen 62
logical units (LUN) used 21
LTO cartridge
 barcode label 25
 barcode label position 26
 capacities 27
 care and handling 30

- environmental specifications **33**
- leader pin **25**
- overview **25**
- types supported **27**
- write-protect switch **25, 27**

LTO drive connector types **13**

LTO drives supported **13**

LTO-9 cartridge initialization **28**

M

magazines

- detailed information **60**
- mailslots **35**
- manual release **35, 88**
- OCP/ **22**
- overview **24, 34**
- slot numbering **34**

Magazines Operations screen **70**

Management Information Block (MIB) **96**

media overview **25**

menu flow indicator **7**

Move Media Operations screen **70**

N

Network Configuration screen **63**

O

OCP

- drive information menu **52**
- functions **18**
- input modes **38**
- LEDs **37**
- modes **36**
- overview **36**
- power button **38**
- rules **37**
- StorageLoader menus **39**
- T24 menus **46**

Operations Screens in RMI **70**

Operator Control Panel (OCP) **36**

Overland-Tandberg Technical Support **9**

P

partitions

- drive naming **76**
- mix of drives **76**
- overview **76**
- single partition **76**

POST process **37**

power button **22**

Power On option **63**

power source specs **20**

power supply

- components **15**

problem detection and reporting **80**

problem diagnostic process **81**

product documentation **8**

R

rear panels

- components **14**

Reboot Service screen **73**

Restore Defaults Configuration screen **69**

RMI

- Configuration screens
 - Date/Time screen **67**
 - Drive screen **63**
 - Email Notification screen **68**
 - License Key screen **62**
 - Log screen **68**
 - Logical Libraries screen **62**
 - Network screen **63**
 - Restore Defaults screen **69**
 - SNMP screen **64**
 - System screen **61**
 - User screen **66**
- functions **18**
- icons **54**
- Identity screens
 - Drive screen **56**
 - Library screen **55**
 - Network screen **57**
- logins **54**
- Operations screens
 - Inventory screen **70**
 - Magazines screen **70**
 - Move Media screen **70**
- overview **53**
- Service screens
 - Cartridge Memory screen **75**
 - Clean Drive screen **74**
 - Drive Diagnostic screen **72**

- Firmware screen **72**
- General Diagnostic screen **71**
- Library Logs screen **73**
- Reboot screen **73**
- Status screens
 - Drive screen **59**
 - Inventory screen **60**
 - Library screen **58**
- room temperature **20**

S

- SAS connections **21**
- SCSI element address reporting **77**
- Service Screens in RMI **71**
- SNMP Configuration screen **64**
- software update **9**
- spares documentation **79**
- specifications
 - electrical **91**
 - environmental **91**
 - hardware **90**
 - operational **90**
- S-Series tape libraries **13**
- supported LTO drives **13**
- System Configuration screen **61**

T

- tape cartridge **25**
- tape drive
 - components **16**
- TapeAlert **96**
- TapeAlert flags **96**
- technical support **9**
- troubleshooting
 - configuration problems **86**
 - drive problems **84**
 - interface problems **85**
 - power problems **84**
 - RMI problems **85**
 - using LEDs **87**
- typographical conventions **6**

U

- User Configuration screen **66**

W

- WORM media **29**
- write-protect switch, LTO **25, 27**