

Spare Rackmount Rail Kit Instructions

This document describes how to remove and replace existing rackmount rails for a NEOxl 40 (3U) tape library module from Overland Storage.

WARNING: To reduce the risk of electric shock or damage to equipment, always remove any power cords while working with the library.

WARNUNG: Um das Risiko eines elektrischen Schlags oder Schäden am Gerät zu vermeiden, ziehen Sie stets den Netzstecker, bevor Sie an der Einheit arbeiten.

AVERTISSEMENT: Pour réduire le risque de choc électrique ou endommagement de l'équipement, retirez toujours les cordons électriques en travaillant avec l'appareil.

CAUTION: While working with the library, observe standard Electrostatic Discharge (ESD) precautions to prevent damage to micro-circuitry or static-sensitive devices.

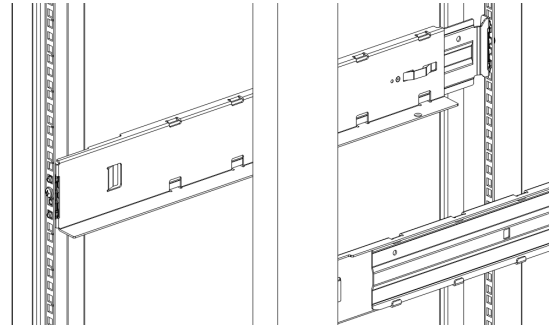

Special Handling Notice

Each NEOxl 40 module weighs more than 44 lbs (20 kg) without drives or tapes and more than 77 lbs (35 kg) with three tape drives and 40 tapes.

Before moving or lifting a module, remove the tape magazines and drives to reduce the weight.

Prepare the Library

Remove Tape Magazines

First, make sure all activities are completed and all backup software services are stopped. Remove both of the tape magazines from the module whose rails are being replaced.

NOTE: If the power to the device is off, you can release the magazines manually. Refer to the [Manual Release Process](#) below.

1. From the OCP or RMI, first select the right magazine and then select **Open Magazine**.
2. Using the right magazine **access handle** and supporting it underneath, pull the magazine out of the library.
3. Place the magazine on a **secure surface**.
4. Repeat [Steps 1–3](#) for the **left magazine**.

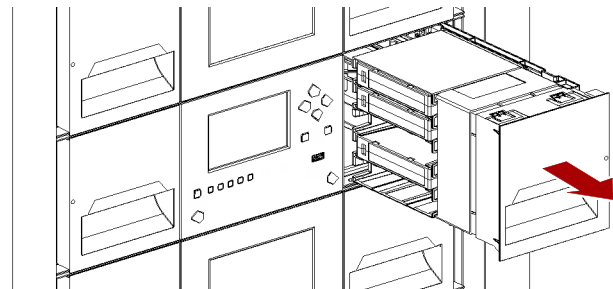

Manual Release Process

If power is not available on the module, the magazines can be released using the manual release holes on the side of the magazines. Insert a small flat-head screwdriver or Torx driver into the release hole and gently push the tab in.

IMPORTANT: Do not continue to exert force once you encounter resistance. Doing so can damage the device.

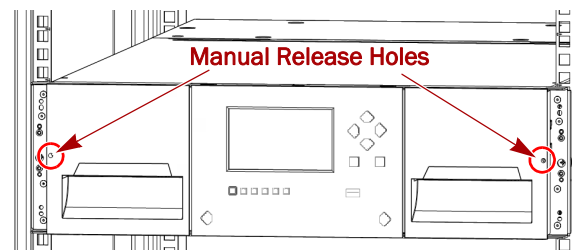

Power Off Library

If still running, power off the library from the Base Module front panel by pressing and holding down the power button for three (3) seconds.

NOTE: *If the library does not perform a soft shutdown, press and hold the power button for 10 seconds.*

Verify that the Robotic Assembly is in its parked position and that all host processes are idle.



Remove Cords and Cables

Disconnect all cords and cables from the module being removed, noting where they connect.

1. If present, unplug any **AC power cords** (1).
2. Remove the **expansion interconnect cables** (2) from the module and any modules to which it is connected.

NOTE: *Completely removing the expansion interconnect cables from the modules prevents damaging the cables during module removal and replacement.*

3. For a Base Module, remove and label any **Ethernet management cables** (3).
4. For a module with drives installed, remove and label the **SAS/FC cables** (4) from the drives.
5. For a Base Module, if present, remove the optional **USB device** (5).

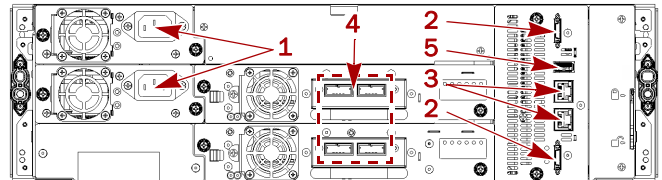

Remove Tape Drives

If installed, remove the tape drives to reduce the weight.

NOTE: *Because the library tracks the drive locations and issues events if the drives aren't in the expected locations, label the drives so they can be reinstalled in the same drive bays.*

1. Use your fingers to loosen the **blue thumbscrews** on the tape drive.
2. While supporting the bottom of the drive, pull straight back on the tape **drive handle** to remove it from the module.

CAUTION: Support the bottom of the tape drive when removing it to avoid damaging any internal connections.

3. Place the drive on a secure **ESD surface**.
4. Repeat **Steps 1–3** for any **additional drives**.

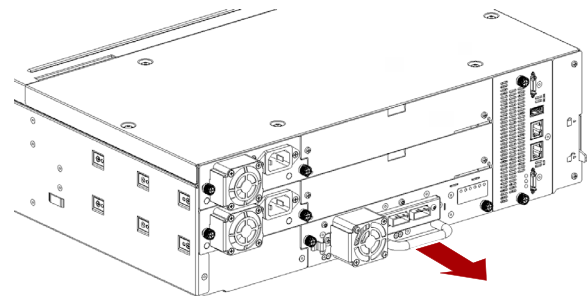

Remove Module from Rack

WARNING: To avoid injury, we recommend the use of a mechanical lifting aid (or at least two persons) for rack installation or removal. Use caution during rack installation or removal to avoid accidentally tilting or tipping the rack and injuring yourself.

WARNUNG: Um Verletzungen zu vermeiden, empfehlen wir zur Rack-Installation oder -Deinstallation die Nutzung einer mechanischen Hebehilfe (oder mindestens zwei Personen). Seien Sie vorsichtig bei der Rack-Installation oder -Entnahme, um ein versehentliches Kippen des Racks zu vermeiden und das Rack nicht zu beschädigen bzw. sich selbst zu verletzen.

AVERTISSEMENT: Afin d'éviter des blessures pendant l'installation, il est recommandé d'utiliser un monte-charge (ou au moins deux personnes) pour élever ou aligner l'module. Faites attention lorsque vous insérez ou retirez l'module d'un support, pour empêcher le déversement accidentel de la crémaillère causant des dommages et des blessures.

1. From the front, use a #2 Phillips screwdriver to loosen the rack **recessed screws** two full turns on both the module being removed and any adjacent modules.
2. From the back of the library, unlock the **alignment mechanisms** connecting the modules.
3. Carefully slide the **module** out onto a mechanical lifter.
4. Place the **module** on a secure ESD surface.
5. Unpack the new **rail kit**.

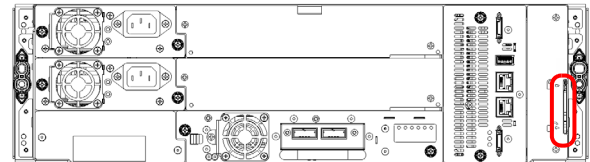
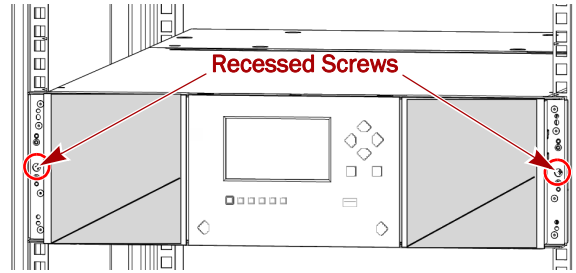

Alignment Release

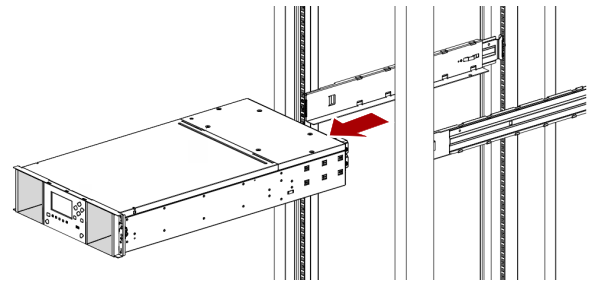

Replace the Rackmount Rails

Remove Old Rails

Remove the old rails and hardware. Set aside for return.

1. Unhook the existing **left rail** from the front and rear adapter blocks and set aside.
2. Unhook the existing **right rail** from the front and rear adapter blocks and set aside.
3. Remove all the **old adapter blocks** by removing the screws securing them in place.

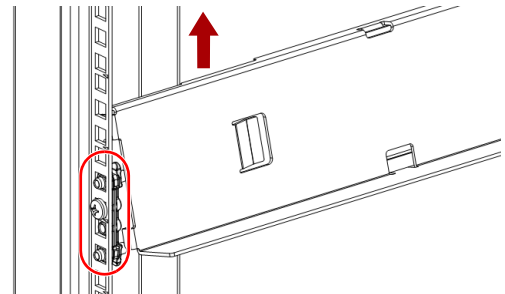

Install New Rails

Install the new rails in the same location.

1. Position the **new adapter blocks** in the same locations as the old ones, securing each one with the provided screw.
2. Hook the **new left rail** to the front and rear left adapter blocks with the tray flange parallel to the floor and facing inward.
3. Hook the **new right rail** to the front and rear right adapter blocks with the tray flange parallel to the floor and facing inward.

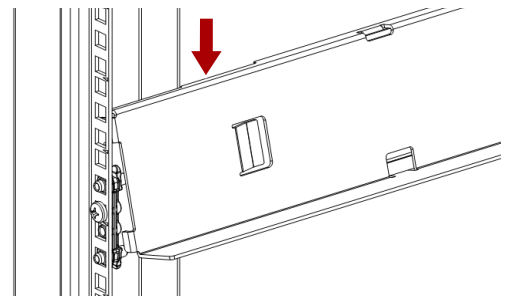

Return the Module to Service

Reinsert the Module

1. Using the mechanical lifter, position the **module** in front of the rack from where it was removed and aligned it with the new rack rails.
2. Slide the module onto the **rack rail flanges** and into the rack.
3. Tighten the **recessed screws** only one turn to hold it.

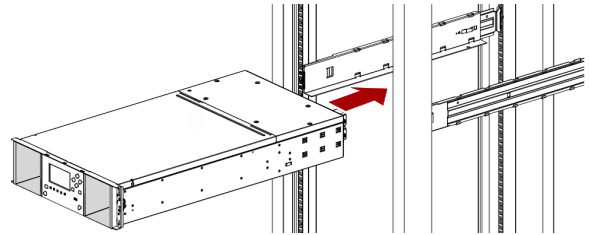

Aligning and Connecting the Module

Aligning the module with the other modules ensures that the Robotic Assembly can move freely between the modules.

NOTE: The library will not operate unless all the alignment mechanisms (except the one on the bottom module) are in the locked position.

1. At the back of the library, using the **alignment lock lever**, align and lock the module to any modules to which it connects.
If you encounter resistance, adjust the upper module so that the alignment mechanism pin moves into the mating hole in the lower module.
2. If necessary, verify that the **lowest** module in the library has its alignment mechanism in the **unlocked position**.
3. At the front of the library, tighten the **recessed screws** on both the effected module and any adjacent modules to secure them all to the rack.

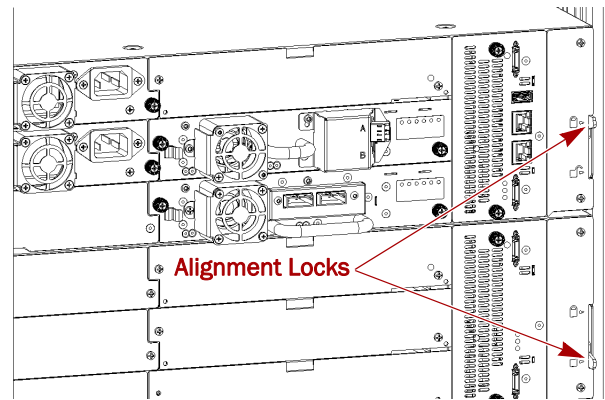

Reinstall Tape Drives

If present, start with the lowest tape drive bay and reinstall them upwards. Ensure that each tape drive is going into its appropriate bay.

1. Holding a **tape drive** by the handle and supporting it from the bottom, position it on the alignment rails.
2. Slowly slide the tape drive into the **drive bay** until it is flush with the back of the library.
3. Finger-tighten the **blue captive thumbscrews** to secure.
4. Moving upwards, repeat [Steps 1–3](#) for any **additional tape drives**.

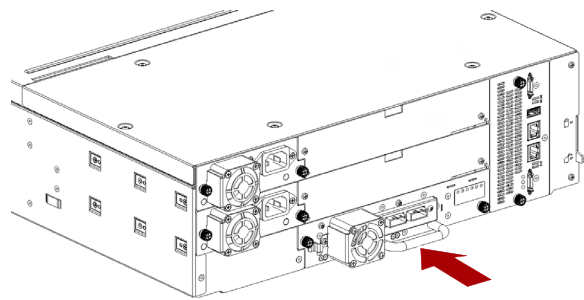

Reattach Cables and Cords

1. If used, reconnect the **expansion interconnect cables** (2) from the module to any adjacent modules.
2. If used, reconnect all **Ethernet management cables** (3).
3. If tape drives are installed, reconnect any **SAS/FC cables** (4) to them.
4. If removed earlier, reinsert the **USB device** (5).
5. If power supplies are installed, reconnect any **AC power cords** (1).

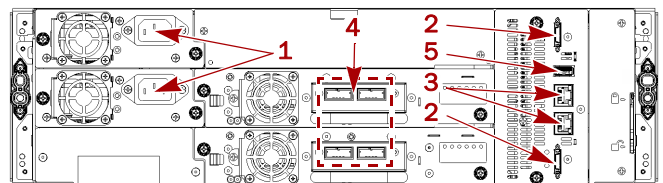

Reinstall Tape Magazines

Reinstall the previously removed tape magazines (and tapes) into the module.

1. Using the magazine **access handle** and supporting it underneath, position the magazine on the alignment rails of the appropriate bay.
2. Slide the **magazine** into the module.
3. Repeat [Steps 1–2](#) for the **other magazine**.

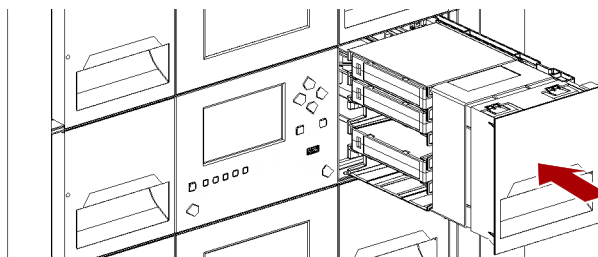

Complete the Procedure

Verifying the Installation and Configuration

Power ON the library and check the following:

- Verify that the library powers ON and initializes correctly, and that the status is Ready.
- Check the library configuration settings related to the additional storage slots, mailslots, and tape drives. Update the settings if necessary.
- If the UID LEDs are still illuminated, deactivate them using the RMI.

It is recommended that you always update the library to the latest firmware version. You can update firmware from the RMI or the OCP **Maintenance > Library Firmware Upgrade** screen.

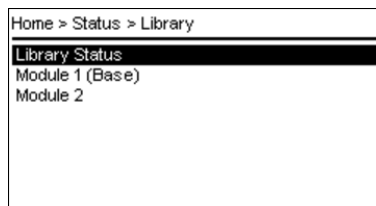

Return Replaced Part to Overland

For warranty replacements:

1. Place the **old rail kit** in the box that the replacement rail kit came in.
2. Use the existing **packing material** to secure it in the box.
3. Use an RMA to return the part to **Overland Storage**.

For return shipping details and RMA number, go to: <http://docs.overlandstorage.com/return-instructions>.

